

DSCL24 (Single Channel)



Jumper Configurable - DIN or Panel Mount

Description

Each single channel DSCL24 module provides up to 36 different configurations of process current or voltage inputs and outputs. A unique snap-in tool allows quick extraction of the module's circuit board to permit the user to reposition four (4) jumpers and reconfigure each module's I/O. The factory default setting provides 4-20mA input and output current.

Each module provides full 3-way isolation with 2300Vrms CMV input to output and 3700Vrms CMV power supply to I/O protection. Two module versions are offered that accept universal power supply of either 24 to 60VDC or AC and 85 to 230VDC or AC with the alternating current usage accepting 45 to 400Hz power.

► Features

- Uses Universal Power Supply of 24 to 60V or 85 to 230V AC/DC
- Configuration Jumpers Allows up to 36 I/O Settings
- Three-Way Isolation for 2300Vrms Protection
- Prevents Ground-Loop Problems
- Prevents the Transfer of Interference Voltages and Currents
- High Accuracy Over Full Span
- No Recalibration or Maintenance Required
- Narrow DIN Package, Mounts up to 27 Devices into a 19" Rack Space
- DIN Rail or Panel Mountable
- CE Compliant

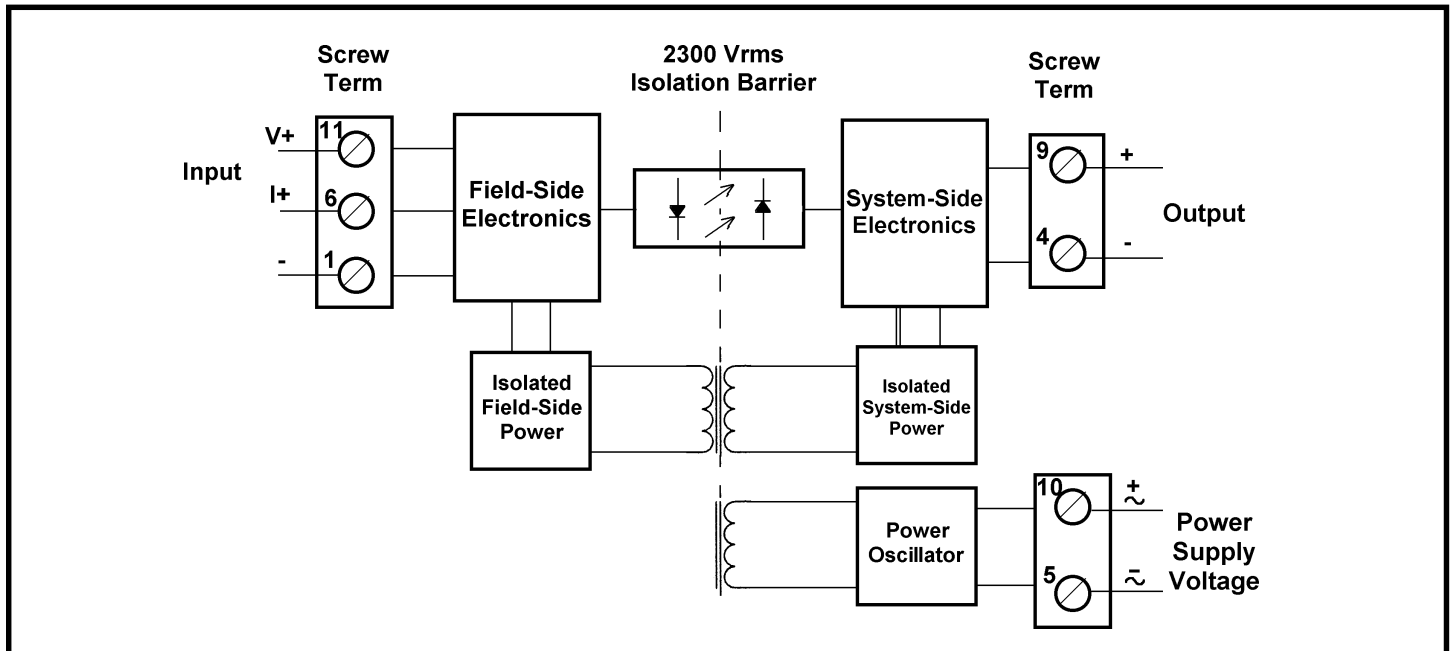

Figure 1: DSCL24 Block Diagram

Specifications Typical at $T_A = +25^\circ\text{C}$ and 24VDC or 230VAC $\pm 10\%$ supply voltage

Module	DSCL24-01,-02
Input Range ⁽¹⁾	0/4-20mA, $\pm 20\text{mA}$, 2-10V, 0-10V, $\pm 10\text{V}$
Input Limit (I_{in})	50mA, $\pm 50\text{mA}$
Input Limit (V_{in})	40V, $\pm 40\text{V}$
CMV Input to Output	2300Vrms, 1 min.
CMV Power Supply to I/O	3700Vrms, 1 min.
Accuracy (at 250 Ω Load)	$\pm 0.1\%$ Span Typical $\pm 0.2\%$ Span Max
Input Resistance	15 Ω Current Mode, 100k Ω Voltage Mode
Non-linearity	Included in Accuracy
Stability	<100ppm/ $^\circ\text{C}$
Input Overshoot	<20 μA (Typical 5 μA)
Output Range ⁽¹⁾	0/4-20mA, $\pm 20\text{mA}$, 2-10V, 0-10V, $\pm 10\text{V}$
Output Limit (I_{out})	20mA, $\pm 20\text{mA}$
Output Limit (V_{out})	10V, $\pm 10\text{V}$
Limit Upper Range	40mA
Bandwidth, -3dB	15Hz
CMR (50Hz or 60Hz)	110dB
NMR	16dB at 50/60 Hz
Response Time	30ms, to 90% Span
Load Resistance Range	$\leq 600\Omega$ Current Mode, $\geq 2k\Omega$ Voltage Mode
Output Noise	<0.5% p-p
Power Supply Voltage	(24 to 60) or (85 to 230)VDC/AC at 45-400Hz
Tolerance	DC -15% to +33%, AC $\pm 15\%$
Power consumption	DC $\leq 1.2\text{W}$, AC $\leq 3\text{VA}$
Environmental Housing Material	Weight Approximately 180g Lexan 940 (UL 94 V-O)
Shock Test	50g (3 Shocks, 6 Axis)
Operating Temp Range	-25 $^\circ\text{C}$ to +55 $^\circ\text{C}$
Storage Temp Range	-40 $^\circ\text{C}$ to +70 $^\circ\text{C}$
Relative Humidity	0 to 75% Noncondensing
Emissions	EN50081-2 (Radiated, Conducted)
Immunity	EN50082-2 (ESD, RF, EFT)

NOTES:
(1) Thirty-six unique I/O ranges are jumper configurable. See Tables 1 & 2 for configuration options.

Configuration Guide

The default setting of factory stock modules is 0 to 20mA for both module input and output, that is, jumpers are inserted in positions B2 and B5 designating 0-20mA input and jumpers ST4 and ST3 are in position for 0 to 20mA current output.

However, the output can be user reconfigured for an alternative voltage or current signal by inserting the plug-in jumpers ST4 and ST3 in the appropriate positions shown in table 1.

Ordering Information

Model	Input (default ⁽¹⁾)	Output (default ⁽¹⁾)	Power Supply
DSCL24-01	4-20mA	4-20mA	24-60VDC/AC
DSCL24-02	4-20mA	4-20mA	85-230VDC/AC

Table 1: Select Output Voltage or Current













Output 	Jumpers	
	ST 4	ST 3
Voltage [V]		
Current [mA]		

Table 2: Select Voltage or Current Ranges

	4...20 mA	0...20 mA	-20...20 mA	2...10 V	0...10 V	-10...10 V
	B1, B4	B2, B4	B3, B4	B1, B4	B2, B4	B3, B4
	B1, B5	B2, B5	B3, B5	B1, B5	B2, B5	B3, B5
	B1, B6	B2, B6	B3, B6	B1, B6	B2, B6	B3, B6
	B1, B4	B2, B4	B3, B4	B1, B4	B2, B4	B3, B4
	B1, B5	B2, B5	B3, B5	B1, B5	B2, B5	B3, B5
	B1, B6	B2, B6	B3, B6	B1, B6	B2, B6	B3, B6

NOTE: B1 through B6 Jumpers marked on PC board

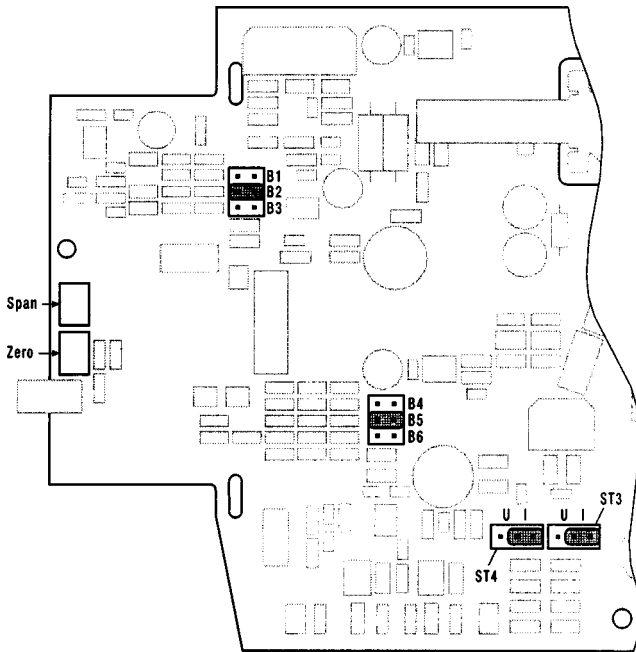

Jumpers B1 to B6 (table 2) are used for selecting the standard configurable ranges. Providing that the 'Span' and 'Zero' potentiometers are not adjusted, changing the range has no effect on the modules' accuracy. The 'Span' and 'Zero' allow $\pm 10\%$ adjustments.

Dimensions

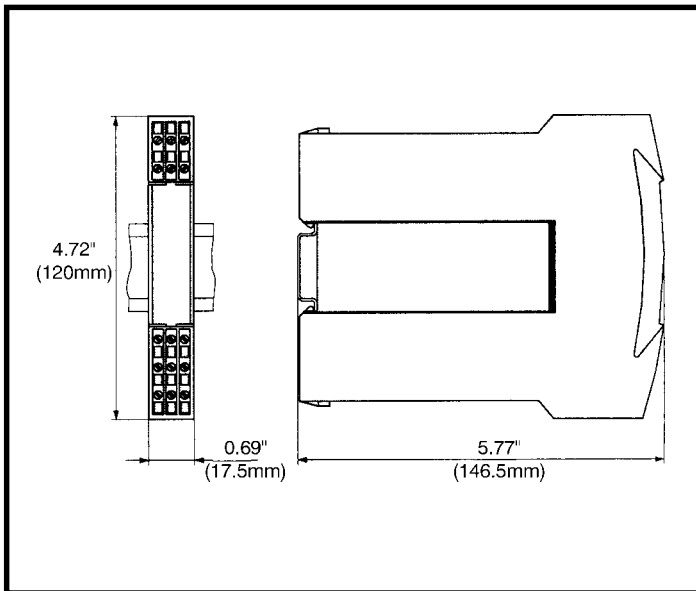

Connection Guide

