



# MAQ<sup>®</sup>20

Industrial Data Acquisition  
and Control System

MA1038

ReDAQ<sup>®</sup> Shape for MAQ<sup>®</sup>20  
User Manual



**MAQ®20 ReDAQ® Shape for MAQ®20 User Manual**  
**MA1038 Rev. E – November 2023**  
**© 2023 Dataforth Corporation. All Rights Reserved.**  
**ISO9001:2015-Registered QMS**

The information in this manual has been checked carefully and is believed to be accurate; however, Dataforth assumes no responsibility for possible inaccuracies or omissions. Specifications are subject to change without notice.

The information, tables, diagrams, and photographs contained herein are the property of Dataforth Corporation. No part of this manual may be reproduced or distributed by any means, electronic, mechanical, or otherwise, for any purpose other than the purchaser's personal use, without the express written consent of Dataforth Corporation.

MAQ®20 is a registered trademark of Dataforth Corporation.  
Windows® is a registered trademark of Microsoft Corporation.  
Measurement Studio™ and LabVIEW™ are trademarks of National Instruments Corporation.

## Table of Contents

<b>Introduction</b> .....	1
1.1 Overview .....	1
1.2 Developer Version and User Version .....	5
1.3 Minimum Host Computer Requirements.....	5
1.4 Installation.....	5
1.5 License Unlock Code .....	5
1.6 Related Documents.....	6
<b>2.0 ReDAQ® Shape for MAQ®20 Integrated Development Environment</b> .....	7
2.1 Start Window .....	7
2.2 Software Menus .....	8
2.3 Tool Bar.....	8
2.4 Panel – Select .....	9
2.5 Status and Message Bar .....	9
<b>3.0 Setup, Configure and Acquire Data in Acquire Panel</b> .....	9
3.1 Acquire Panel.....	9
3.2 Communication Module.....	12
3.3 Analog Input Modules .....	16
3.4 Analog Output Modules .....	20
3.5 Discrete Input-Output Module.....	22
<b>4.0 Test, Process, and Analyze Data in Analyze Panel</b> .....	27
4.1 Analyze Panel .....	27
4.2 View Raw Data .....	28
4.3 View Analog Input Channels.....	29
4.4 View Discrete I/O Channels Tab.....	30
4.5 Read / Write Modbus Registers .....	31
<b>5.0 Create User Interfaces and Edit Tools in the Present Panel</b> .....	32
5.1 Present Panel.....	32
5.2 Toolbox Usage .....	34
5.3 Toolbox Tools.....	35
5.3.1 Chart Recorder Tool .....	37
5.3.2 Scope Tool .....	38
5.3.3 XY Plot Tool .....	39
5.3.4 Discrete Waveform Graph Tool .....	40
5.3.5 Knob Tool .....	41

5.3.6	Meter Tool .....	42
5.3.7	Gauge Tool .....	43
5.3.8	Tank Tool.....	44
5.3.9	Slide Tool.....	45
5.3.10	Thermometer Tool .....	46
5.3.11	Numeric Edit Tool .....	47
5.3.12	Switch Tool .....	48
5.3.13	LED Tool .....	49
5.3.14	Label Tool .....	50
5.3.15	Group Box Tool .....	51
5.3.16	Picture Box Tool.....	52
5.3.17	Text Box Tool .....	53
6.0	Quick Start Examples .....	54
6.1	Closed Loop Control .....	54
6.2	PID – Tank Level Controller.....	56
6.2.1	PID – Temperature and Flow Controller.....	58
6.3	SCMPB01 Backpanel Display .....	60
6.4	Battery Cell Monitor.....	61
6.5	Remote Weather Station .....	63
6.6	Process Simulator .....	65
7.0	Advance Features .....	67
7.1	Modbus TCP Logger .....	67
7.2	Manual Module Registration Mode.....	68

## About Dataforth Corporation

“Our passion at Dataforth Corporation is designing, manufacturing, and marketing the best possible signal conditioning and data communication products. Our mission is setting new standards of product quality, performance, and customer service.” Dataforth Corporation, with over 20 years experience, is the worldwide leader in Instrument Class™ Industrial Electronics—rugged, high performance signal conditioning and data communication products that play a vital role in maintaining the integrity of industrial automation, data acquisition, and quality assurance systems. Our products directly connect to most industrial sensors and protect valuable measurement and control signals and equipment from the dangerous and degrading effects of noise, transient power surges, internal ground loops, and other hazards present in industrial environments.

Dataforth spans the globe with over 50 International Distributors and US Representative Companies. Our customers benefit from a team of over 130 sales people highly trained in the application of precision products for industrial markets. In addition, we have a team of application engineers in our Tucson factory ready to address and solve any in-depth application questions. Upon receipt of an RFQ or order, our Customer Service Department provides fast one-day response of delivery information. We maintain an ample inventory that allows small quantity orders to be shipped from stock.

Dataforth operates under an ISO9001:2015 quality management system.

## Contacting Dataforth Corporation

Contact Method	Contact Information
<b>E-Mail:</b> Technical Support	<a href="mailto:support@dataforth.com">support@dataforth.com</a>
<b>Website:</b>	<a href="http://www.dataforth.com">www.dataforth.com</a>
<b>Phone:</b>	520-741-1404 and toll free 800-444-7644
<b>Fax:</b>	520-741-0762
<b>Mail:</b>	Dataforth Corporation 3331 E. Hemisphere Loop Tucson, AZ 85706

## Errata Sheets

Refer to the Technical Support area of Dataforth’s web site ([www.dataforth.com](http://www.dataforth.com)) for any errata information on this product.



## Introduction

### 1.1 Overview

ReDAQ® Shape Software for the MAQ®20 Industrial Data Acquisition and Control System is Dataforth's out-of-the-box data acquisition software which provides the easiest and most efficient development tool to create, save, and open graphical user interface projects as well as to test, process, and analyze acquired data. It can also log data to the hard drive, and copy, and delete data at runtime. Simple data acquisition starts with a **built-in function** (e.g., scope, I/O special function, and data view spreadsheet) in the Acquire and Analyze panels which can be used without setup and configuration. In addition, it takes only **three easy steps** to create Present panels for projects using 18 Tools for I/O control and monitoring and powerful functions like automatic control loops and timers.

#### For easy data acquisition without detailed setup and configuration:

- Power the system and select the communication options from the Acquire panel.

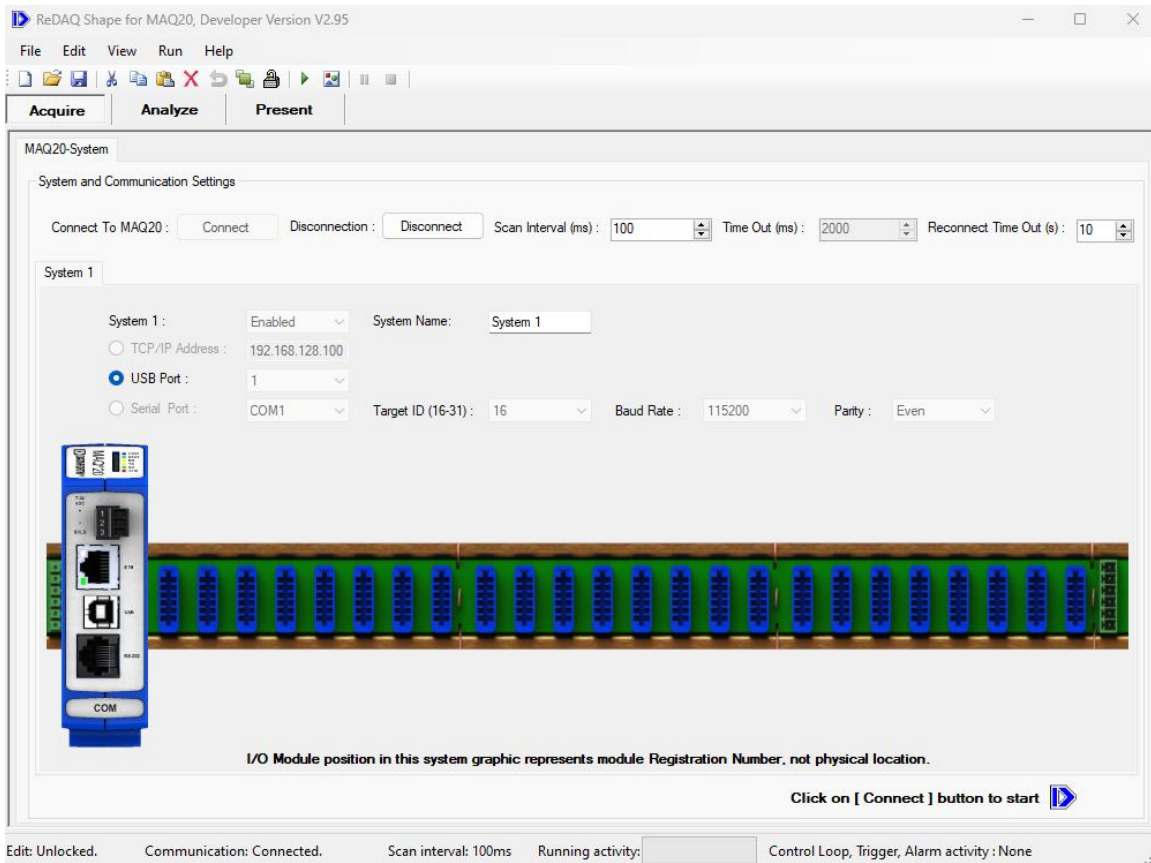

- Click on the [Connect] or [RUN] button , then view and process the data on the Acquire and Analyze panels. The main system panel will display all installed MAQ®20 I/O modules. The status bar at the bottom of the panel provides indications of current activities including Edit Lock, Communication Status, Scan Interval, Running Activity, and Control Loop/Alarm Output Activity.

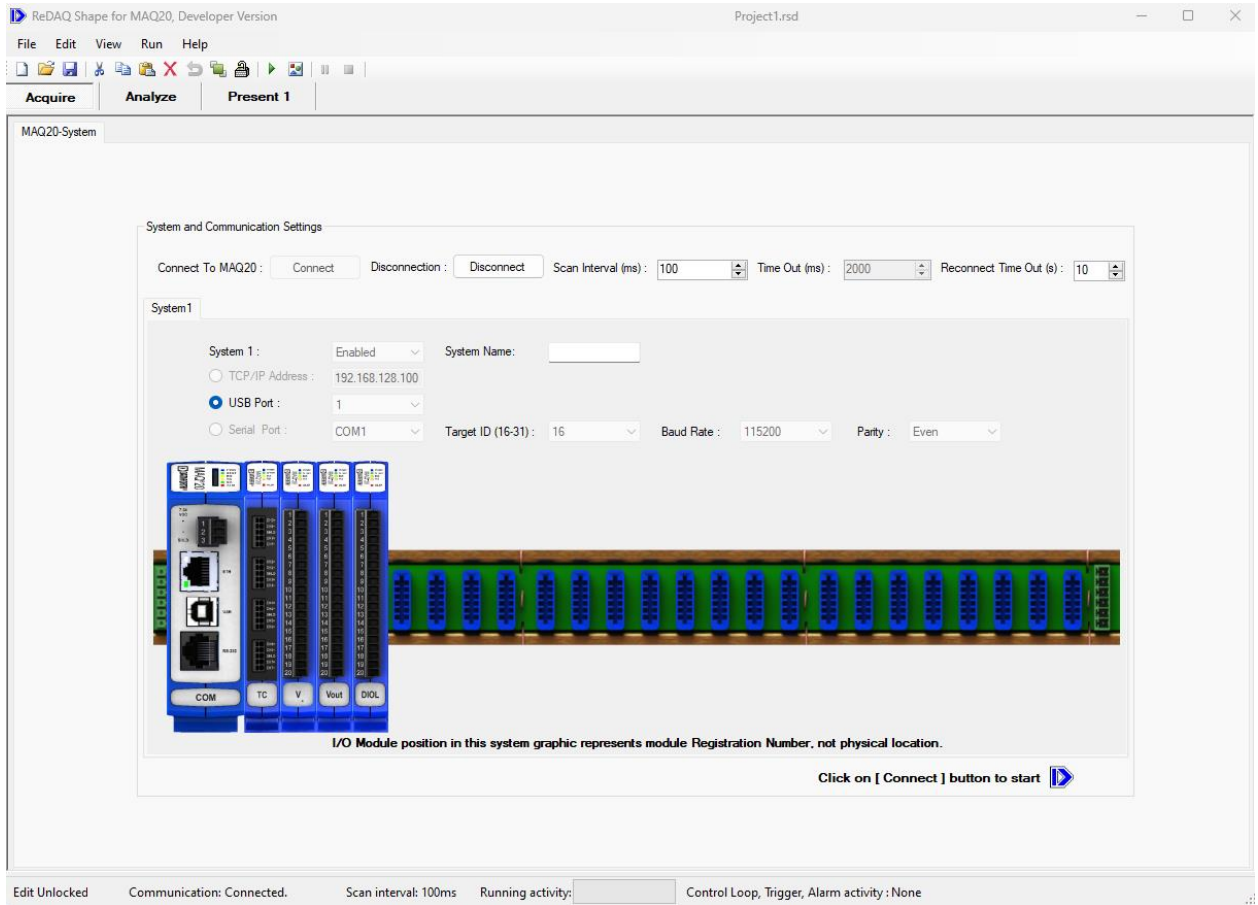

**To create Present panels for application projects:**

- Select Acquire panel for quick setup and click on the [Connect] button to connect to the MAQ®20 system as well as testing and acquisition of data.
- Select Analyze panel to allow data logging, real-time analysis, and data processing.
- Select Present panel to build and create custom graphical user interfaces.

**After selecting a Present panel, use Tools such as Switch, Scope, LED, etc. to build a project. Open the Toolbox with the  icon, select a tool, then click in the Present panel to place the tool in the project. Double click on a Tool in the Present panel to open the properties window. Change properties as desired and click the Start button to run. See Section 5 for details on creating a Present panel.**



The following illustrates a Present panel project:

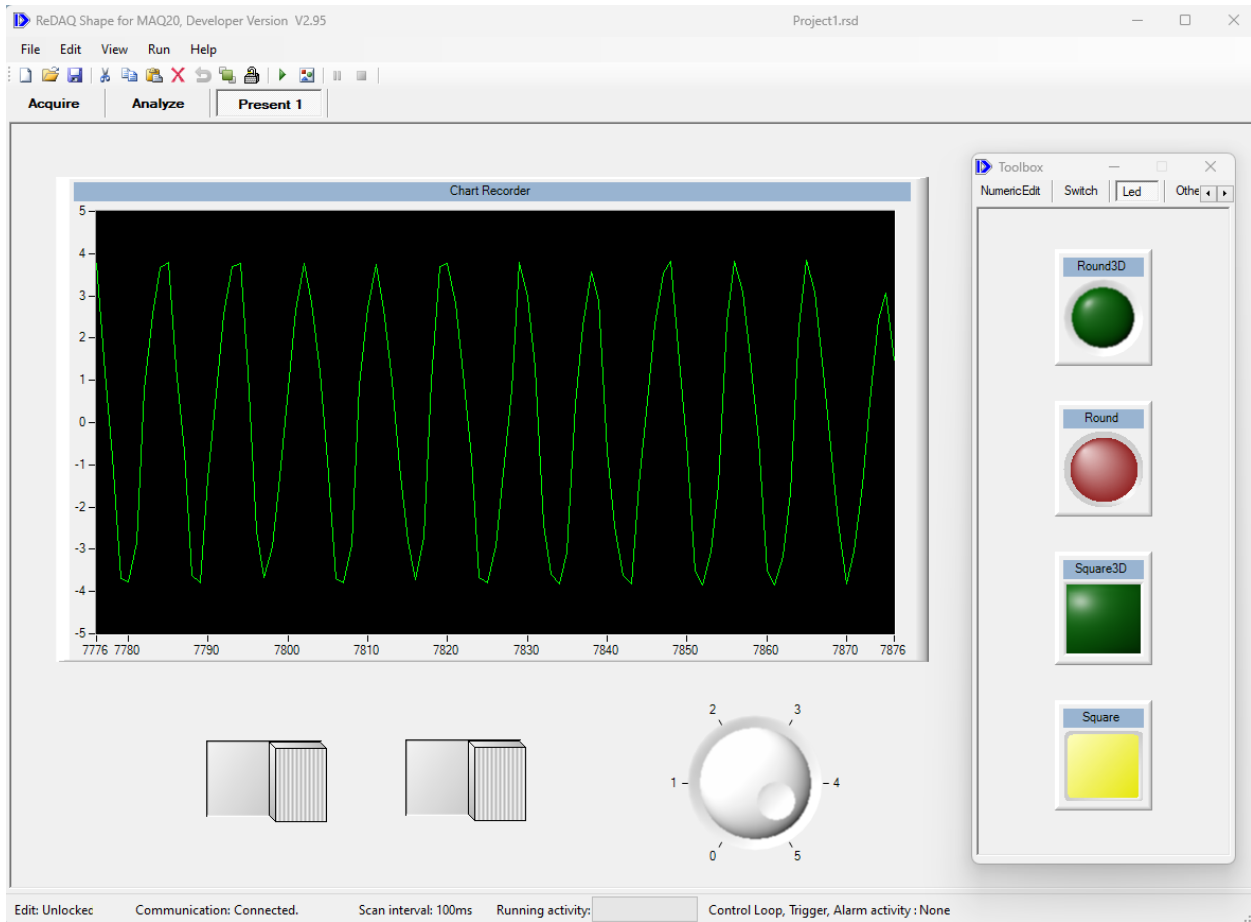

ReDAQ® Shape Software for MAQ®20 offers 18 different types of Tools for building applications:

The Graph group contains:

- Chart Recorder
- Scope
- XY plot
- Discrete Waveform Graph

The Knob group contains:

- 5 styles of Knobs

The Meter group contains:

- 4 styles of Meters

The Gauge group contains:

- 6 styles of Gauges

The Tank group contains:

- 6 styles of Tanks

The Slide group contains:

- 6 styles of Slides

The Thermometer group contains:

- 6 styles of Thermometers

The Numeric Edit group contains:

- 4 styles of Numeric Edit

The Switch group contains:

- 14 styles of Pushbutton, Slide, Rocker, and Toggle Switches

The LED group contains:

- 4 styles of LEDs

The Other Controls group contains:

- Label
- Button with High Level Timer functions
- Group Box
- Picture Box
- Text Box

All the Tools are easily selected to create, move, resize, cut, copy, paste, and delete. Double click on the selection to set its properties. These Tools also support many graphical file formats, so users may use common software to create a graphical representation of a process and load it into ReDAQ® Shape Software for MAQ®20.

## 1.2 Developer Version and User Version

There are two versions of the software, Developer and User. The Developer version is fully functional with the capability of creating a project, configuring the Tools, and setting up the parameters of MAQ®20 COM and I/O modules. The User version can only run finished projects that were created using the Developer version and is for use in applications where a user does not have the ability to modify a project.

Both versions of ReDAQ® Shape Software for MAQ®20 can be installed on the same computer.

After a project is complete, it can be saved as a User project and distributed. A User project can only be run with the User version of ReDAQ® Shape Software for MAQ®20.

A ReDAQ® Shape for MAQ®20 project file has two parts:

- A projects file with extension.rsd (Developer version) or .rsu (User version). Examples are 'project1.rsd' or 'project1.rsu'.
- A folder which includes all the image and text files of the project. The folder name is <project name> + 'Images' (Developer version) or <project name> + 'ImagesUser' (User version). Examples are 'project1Images' or 'project1ImagesUser'.

## 1.3 Minimum Host Computer Requirements

Before installing ReDAQ® Shape Software for MAQ®20, verify that the host computer meets the following minimum requirements:

- Microsoft Windows 2000/XP/Vista/Win7/Win10/Win11 operating system.
- Video display – 800x600, 256 color (16-bit recommended), or higher.
- Minimum of 256MB of RAM (512MB or higher recommended).
- Minimum of 400MB of free hard disk space.

## 1.4 Installation

To install ReDAQ® Shape Software for MAQ®20, complete the following steps:

- Download the Developer version and/or User version from the Dataforth website, [www.dataforth.com](http://www.dataforth.com).
- Extract the files from the downloaded .zip file and run setup.exe.
- Follow the installation instructions in the setup program.

If the system will be used with a USB connection the **USB Driver** must be installed prior to connecting the system to the computer. The ReDAQ® Shape Software installer will present the option to install the USB driver during program installation if the driver is not already present on the host machine.

## 1.5 License Unlock Code

ReDAQ® Shape Software for MAQ®20 is available for download free of charge from the Dataforth website, [www.dataforth.com](http://www.dataforth.com). It is fully functional software and can be used for evaluation, testing and development, but will only run for 30 minutes. Order the License Unlock Code, part number MAQ20-940

(Developer Version) and/or MAQ20-941 for (User version) from Dataforth Corporation to enable unlimited use.

The License Unlock Code is tied to the serial number of the COM module of MAQ®20 Data Acquisition System being used. To install the License Unlock Code and hardware serial number in the software, open the Enter License Unlock Code window from the Help menu, then type or copy/paste the information into the fields provided. Up to 10 unlock codes can be entered to interface to up to 10 MAQ®20 Data Acquisition Systems. The MAQ®20 COM module serial number must have the format of a 7-digit main number followed by a 2-digit suffix. If the main number has fewer than 7-digits or the suffix has a single digit, use leading zeros to obtain the correct format (i.e., serial number 12345-6 must be entered as 0012345-06).

The screenshot shows a dialog box titled "Enter License Unlock Code". It contains two columns of text input fields. The first column is labeled "Serial Number" and the second is labeled "License Unlock Code". The first field in the "Serial Number" column contains the text "1234567-89". The first field in the "License Unlock Code" column contains the text "10942-61233-37842-53419-13018-66035". There are ten empty text boxes in each column below the first one. An "OK" button is located at the bottom center of the dialog box.

## 1.6 Related Documents

The following documents are available for download from the Dataforth Corporation website, [www.dataforth.com](http://www.dataforth.com):

- MA1036 MAQ20 Quick Start Guide
- MA1038 ReDAQ® Shape for MAQ®20 User Manual (this manual)
- MA1039 MAQ20 LabVIEW VI Examples User Manual
- MA1064 MAQ20 Python API User Manual
- MA10xx MAQ20 Hardware User Manual (I/O Module specific)
- MA1056 PID Controller User Manual

The following documents are available from Modbus IDA ([www.modbus.org](http://www.modbus.org)):

- Modbus Application Protocol Specification
- Modbus over Serial Line Specification & Implementation Guide
- Modbus Messaging on TCP/IP Implementation Guide

The following Tools and documents are available from FieldTalk ([www.modbusdriver.com](http://www.modbusdriver.com)):

- Modbus Protocol Drivers and DLL Libraries
- FieldTalk User Manual

The following Tools and documents are available from National Instruments ([www.ni.com](http://www.ni.com)):

- Free Modbus Protocol Drivers VI's and Examples
- LabVIEW User Manual
- Measurement Studio User Manual

## 2.0 ReDAQ® Shape for MAQ®20 Integrated Development Environment

### 2.1 Start Window

After starting ReDAQ® Shape for MAQ®20, the setting dialog box will be displayed for selecting settings, configurations of development environment, and system parameters. The user can select the previous project settings [Yes] or the MAQ®20 system hardware settings [No].

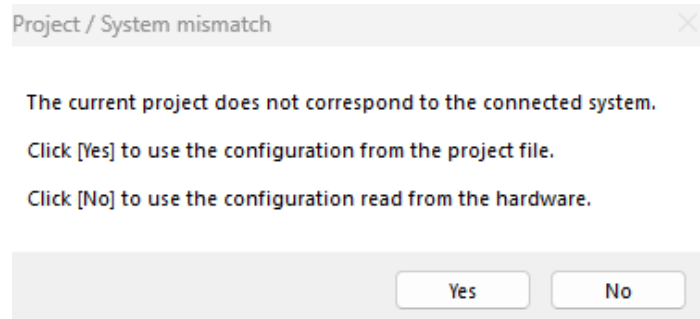

The Interactive Development Environment (IDE) of ReDAQ® Shape for MAQ®20 provides a user friendly and comprehensive interface with easy-to-use pull-down menus, convenient toolbars, and three development panels [Acquire-Analyze-Present], which provide easy methods to setup, configure, and operate the MAQ®20 Data Acquisition System. Users can develop application specific interfaces, projects, and automatic control loops to process, analyze, and acquire data.

## 2.2 Software Menus

There are 5 main pull-down menus: **File Edit View Run Help**

File:

- **Open new project** - Start a new project and reset Acquire, Analyze, and Present panels to default settings.
- **Open existing project** – Open an existing project that was previously saved.
- **Save project** - Save the project to a file <filename>.rsd. Each project also includes image files and text files in a separate folder titled <filename>Images.
- **Save project for user only** - Save the project to a User file <filename>.rsu. Each project also includes image files and text files in a separate folder titled <filename>ImagesUser.
- **Exit** - close ReDAQ® Shape for MAQ®20.

Edit:

- **Cut Tool** - Delete the selected Tool and send it to the clipboard.
- **Copy Tool** - Copy a selected Tool and send it to the clipboard.
- **Paste Tool** - Paste a Tool to a Present panel.
- **Delete Tool** - Delete a Tool from a Present panel.
- **Undo Delete Tool** - Undo the last deleted item on the Present panel.
- **Bring Tool to Front** - Bring item to front/top layer of Present Panel.
- **Edit Lock/Unlock** - Select lock or unlock editing functions.

View:

- **Present Panel** - Add or remove a Present panel.
- **Acquire Panel** - Show or hide the Acquire panel.
- **Analyze Panel** - Show or hide the Analyze panel.
- **Toolbox** - Open or close the Toolbox.
- **Advance Settings** – Enable or disable Manual Module Registration Mode or Modbus Logger functionalities.

Run:

- **Start** - Setup all the parameters of the MAQ®20 from the Acquire panel and run.
- **Pause** - Keeps the parameter settings and pauses run. Click again to continue.
- **Stop** - Stop and reset all parameters.

Help:

- **ReDAQ® Shape for MAQ®20 User Manual**
- **Enter License Unlock Code**
- **About** - ReDAQ® Shape for MAQ®20 version information.

## 2.3 Tool Bar

There are 14 convenient tools located on the tool bar:



Open New Project  
Open Existing Project  
Save Project  
Cut  
Copy  
Paste  
Delete

Undo Delete  
 Bring Tool to Front  
 Edit Lock/Unlock  
 Toolbox Open/Close  
 Start  
 Pause  
 Stop

## 2.4 Panel – Select

A given project can have one Acquire panel, one Analyze panel, and up to 20 Present panels.

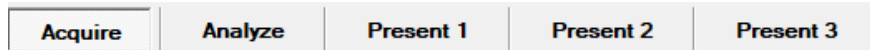

The Acquire and Analyze panels can be hidden or shown using the View pull-down menu. The Present panels can be added, removed, or renamed.

## 2.5 Status and Message Bar

The status and message bar are located at the bottom of the main software panel. It includes 5 types of information.

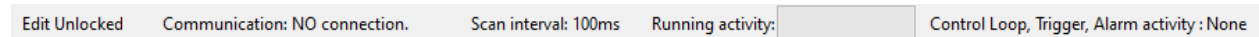

- **Edit** - Shows the edit lock/unlock status.
- **Communication** - Shows the connection status and any communication error messages.
- **Scan interval** - Shows the current scan interval setting.
- **Running activity** - Shows start, pause, or stop activity using a progress bar.
- **Control Loop/Alarm Output activity** - Shows the Control Loop or Alarm Output activity by indicating analog channels which have reached a specified preset alarm condition. None = no channels have current alarm activity.

## 3.0 Setup, Configure and Acquire Data in Acquire Panel

### 3.1 Acquire Panel

The Acquire panel provides setup, configuration, and the ability to read and write data to/from the MAQ®20 Data Acquisition System. A system is made up of one communications module and up to 24 I/O modules.

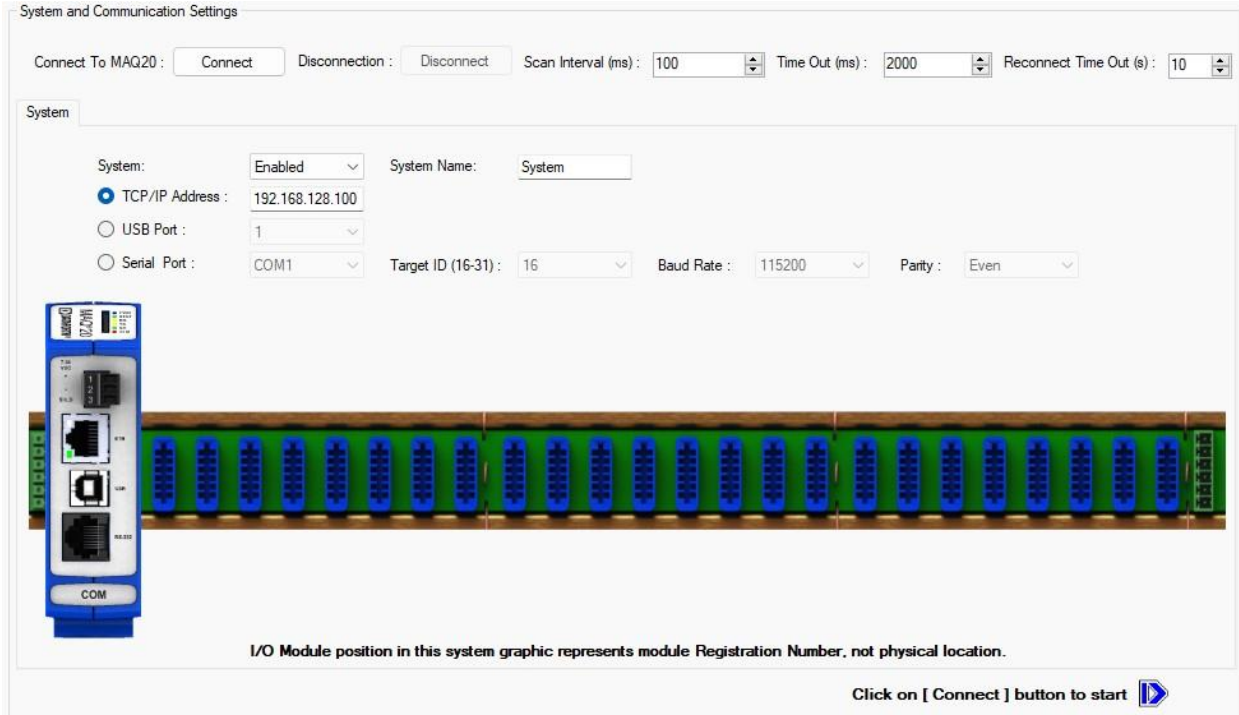

Before an application can be run, the system must be configured using the Acquire panel.

- Enable system connected: Enabled (Default).
- System Name: System (Default).
- Select the communication port for the system: Ethernet (Default), USB, or Serial.  
**IP Address:** 192.168.128.100 (Default).  
**USB:** Port 1 (Default).  
**Serial port name:** COM1-COM20.  
**Target ID:** 16 (Default).  
**Serial port baud rate:** 921600, 460800, 230400, 115200 (Default), 57600, 38400, 19200, 9600, 4800, 2400.  
**Parity:** EVEN (Default), NONE, and ODD.
- Select system run interval in milliseconds: 100 (Default).
- Select communications timeout in milliseconds: 2000 (Default).
- Select reconnect timeout in seconds: 10 (Default).

To establish communications with the system, click on the [Connect] button. When using the Ethernet interface, up to four simultaneous socket connections are supported and each socket can process up to four simultaneous Modbus TCP transactions. Serial communications over RS-232 or RS-485 can be run at baud rates as fast as 921.6kbps.

The communications module will automatically detect which MAQ20 I/O modules are installed (TC, VDN, Vout, DIOL, etc.) and the software will generate a graphical representation of the entire system. The individual I/O modules in the system can be set up by clicking on the image of the modules to open a configuration panel specific to each I/O module type.



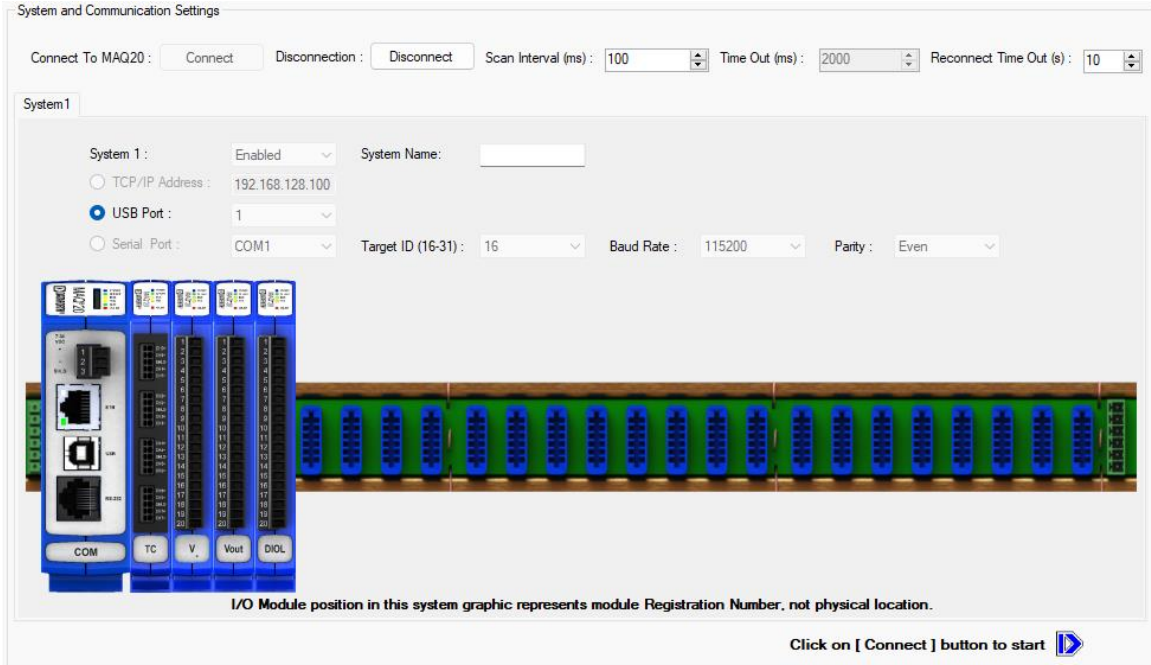

After setup, the Acquire panel can be hidden using the View pull-down menu as follows:

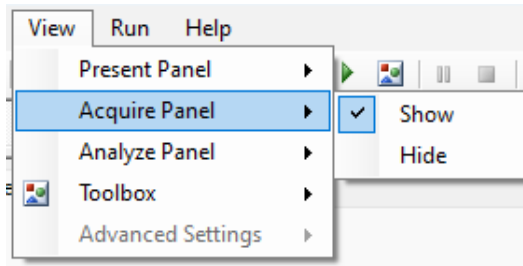

### 3.2 Communication Module

To setup and configure the communications (COM) module, click on the COM module graphic. The COM module setting panel has four tabs [System Summary], [Setup COM], [SD Memory Card], and [Data Converter].

- **System Summary Tab:**

Device: MAQ20-COM4, Serial Number: 0147878-12, MAC: 70:B3:D5:6F:A2:1D, Date Code: D0221, Firmware version: F1.72, Temperature: 49°C

Return

System Summary Setup COM SD Memory Card Data Converter

Up Down Save

	Registration #	Start Address	Model Number	Serial Number	Date Code	Firmware	Inputs	Outputs
▶	1	2000	MAQ20-JTC	0154134-01	D1122	F2.71	8	0
	2	4000	MAQ20-VDN	0143330-04	D1122	F2.71	8	0
	3	6000	MAQ20-VO	0153470-03	D1121	F2.70	0	8
	4	8000	MAQ20-DIOL	0153366-04	D1121	F1.12	5	5
	5							
	6							
	7							
	8							
	9							
	10							
	11							
	12							
	13							
	14							
	15							

Basic information for all modules in the system are displayed at the top of the panel including model number, serial number, date code, firmware revision, and Modbus start address in the system map.

When power is applied for the first time to a system, the COM module automatically registers all I/O modules in the system. The registration sequence by slot number is displayed in the COM module configuration panel. This sequence may not match the actual physical sequence of the I/O modules in the system. To change the slot number in the software, click on the row to select the module, then use the [Up] and [Down] buttons to move the module to the slot number which matches the actual physical location.

Click on the [Save] button to save the changes. The system configuration is now stored in the COM module's nonvolatile memory and I/O modules will be shown in the same slots for all subsequent power cycles.

- **Setup COM Tab:**

Device: MAQ20-COM4, Serial Number: 0147878-12, MAC: 70:B3:D5:6F:A2:1D, Date Code: D0221, Firmware version: F1.72, Temperature: 48°C

Return

System Summary Setup COM SD Memory Card Data Converter

**Communication**

**Serial Communication Settings**

Target ID (16-31):

Baud Rate:  Parity:

**TCP/IP Settings**

IP Address:  Subnet Mask:

Timeout [s]:  Gateway:

Gratuitous ARP  Gratuitous ARP Period (s):

Boot Count:  Time Since Last Boot (s):

**Notes**

- Changes made to the Communication Setting do not take effect until the next power cycle.
- Data is read from the SD Card in the MAQ20-COMx module through FTP.
- For FTP reading, an Ethernet connection to the MAQ20-COMx module is required
- The default FTP Server settings are: Username = "maq20", Password = "1234"

**FTP Settings**

Username:  Password:

**Real Time Clock**

Day Of Week	Month	Day	Year	Hour	Minute	Second	
<input type="text" value="3"/>	<input type="text" value="3"/>	<input type="text" value="21"/>	<input type="text" value="23"/>	<input type="text" value="13"/>	<input type="text" value="27"/>	<input type="text" value="30"/>	Set To System Date/Time

Manual Set RTC

Save Settings to Module Memory

Communication Parameters such as Slave ID, Serial Baud Rate, Parity, Gratuitous ARP, IP Address, Gateway, and Subnet mask are modified using this panel. Click on the [Save Settings to Module Memory] button to store changes in the COM module's nonvolatile memory. **Changes made to the communications settings do not take effect until the system power has been removed and restored.**

Real Time Clock: The Real Time Clock can be set based on the host computer's time/date by clicking the [Set to System Date/Time] button and then clicking the [Save Settings to Module Memory] button. The Real Time Clock can also be set manually by selecting the [Manual Set RTC] button, editing the time fields, and then selecting the [Save RTC] Button.

- **SD Memory Card Tab:**

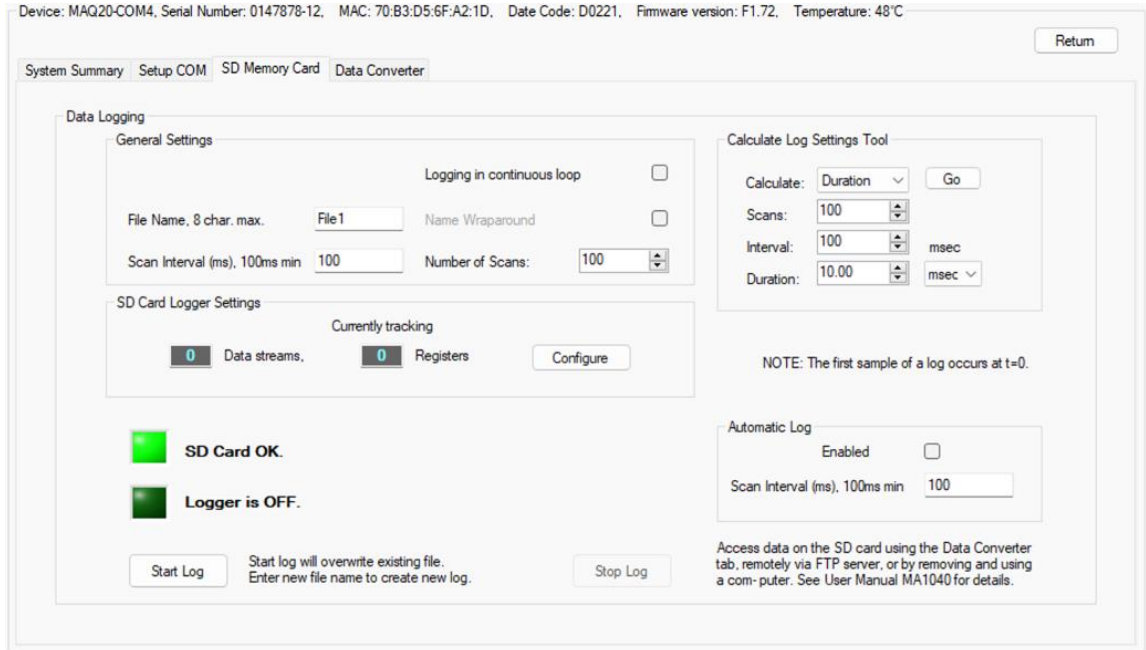

This tab provides a simple interface to set up data logging parameters, start/stop data logging, and verify logging activity.

Enter the desired file name in the File Name text box. The filename must be a maximum of 8 characters and follow standard MS Windows naming convention. The default filename is 'File1'.

Time between logged samples is entered in the Scan Interval input box. 100ms is the minimum and default interval value for this field. Number of Scans specifies the total number of data retrieval events to occur within the time frame specified by the Scan Interval value. The default is 100 scans.

Configuration of data to be logged is initialized through a configuration window that appears upon clicking the [Configure] button. The configuration pop-up window allows selection of logging from all attached modules. Quantity of logged registers defaults to values related to available channels on the module. Refer to the MA10xx MAQ®20 Hardware User Manuals for a complete listing of Modbus register addresses.

To start logging data, click the [Start Log] button.

To stop logging data, click the [Stop Log] button.

Logging in continuous loop allows for a new file to be created upon completion of the specified logging parameters. If Name Wraparound is selected along with the Logging in a continuous loop option, each new filename will be incremented by one integer value.

NOTE: To retrieve data from the micro-SD card, remove it from the system, place it in the provided USB adapter and read the card using the host computer or another appropriate system. Alternatively, data can be retrieved using the functions in the Data Converter tab if the system is connected through TCP.

The Automatic Log feature is a quick method for setting up SD card logging of all modules in the system. The feature can be enabled by marking the checkbox in the Automatic log box.

• **Data Converter Tab:**

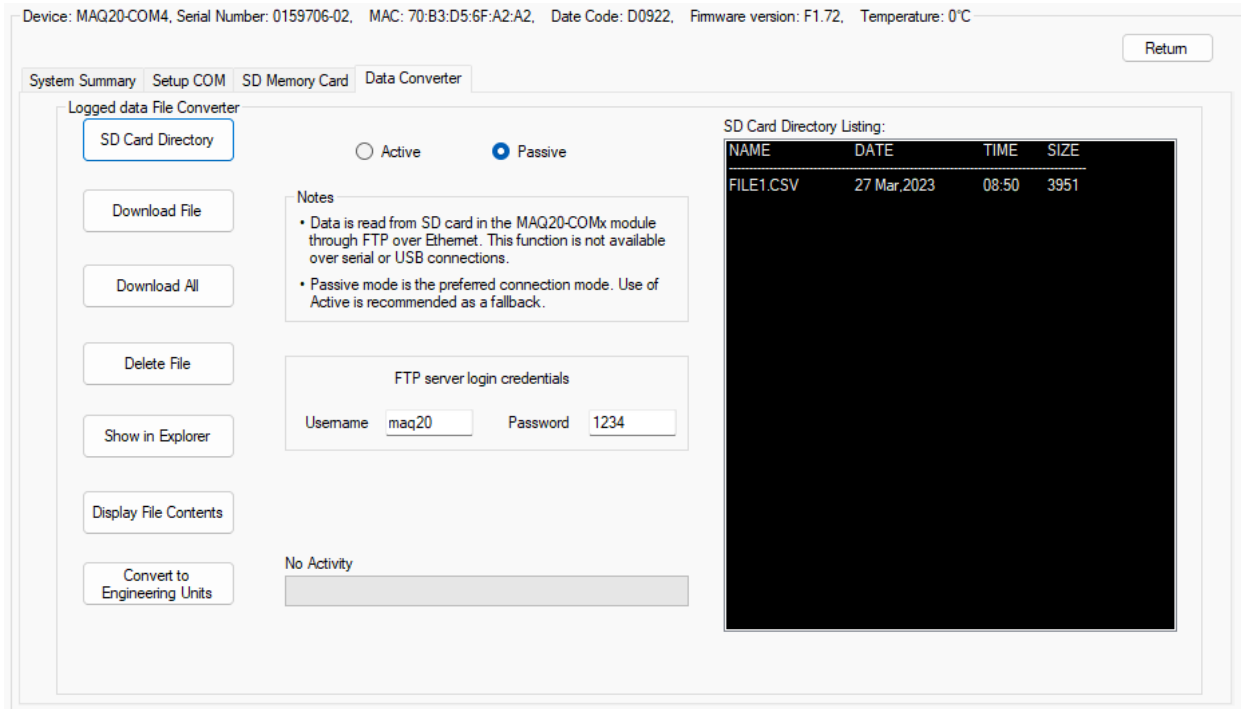

This tab provides a simple interface to access logged data from the micro-SD card when the system is connected through TCP. Click the [SD Card Directory] button to display the file contents currently present in the micro-SD card. Individual files can be downloaded to the host system by click on the desired file in the SD Card Directory Listing window and then clicking the [Download File] button. Alternatively, all files can be downloaded at once by clicking the [SD Card Directory] button then clicking the [Download All] button. Clicking the [Show in Explorer] button will open the downloaded file location in the host operating system.

Individual file contents can be viewed without first downloading by use of the [Display File Contents] button after selection of the specified file in the SD Card Directory Listing window.

Files downloaded from the micro-SD card contain data in raw count format. Select the desired file in the SD Card Directory Listing window then click the [Convert to Engineering Units] button to convert the data in the file to engineering units.

Files can be deleted from the micro-SD card by clicking the [SD Card Directory] button then selecting a file in the SD Card Directory Listing window, and subsequently clicking the [Delete File] button.

Micro-SD card content can also be accessed in-system during system idle or system operation using the MAQ®20 built in FTP Server. FTP server credentials can be entered in the fields located within the FTP server login credentials box. The FTP server in each MAQ20-COMx module supports Passive and Active connections with limited FTP commands.

### 3.3 Analog Input Modules

The Analog Input Module configuration panel has three tabs [Setup], [Scale Data], and [Control Loop, Trigger and Alarm] that provide a simple interface to configure and collect data from analog input modules such as MAQ20-MVDN, -VSN, -VDN, -ISN, -IDN, -RTD31, -RTD41, -BRDG1, -JTC, -KTC, -TTC, -RSTC, etc. To open the analog input module configuration panel, click on the input module graphic in the system representation.

- **Setup Tab:**

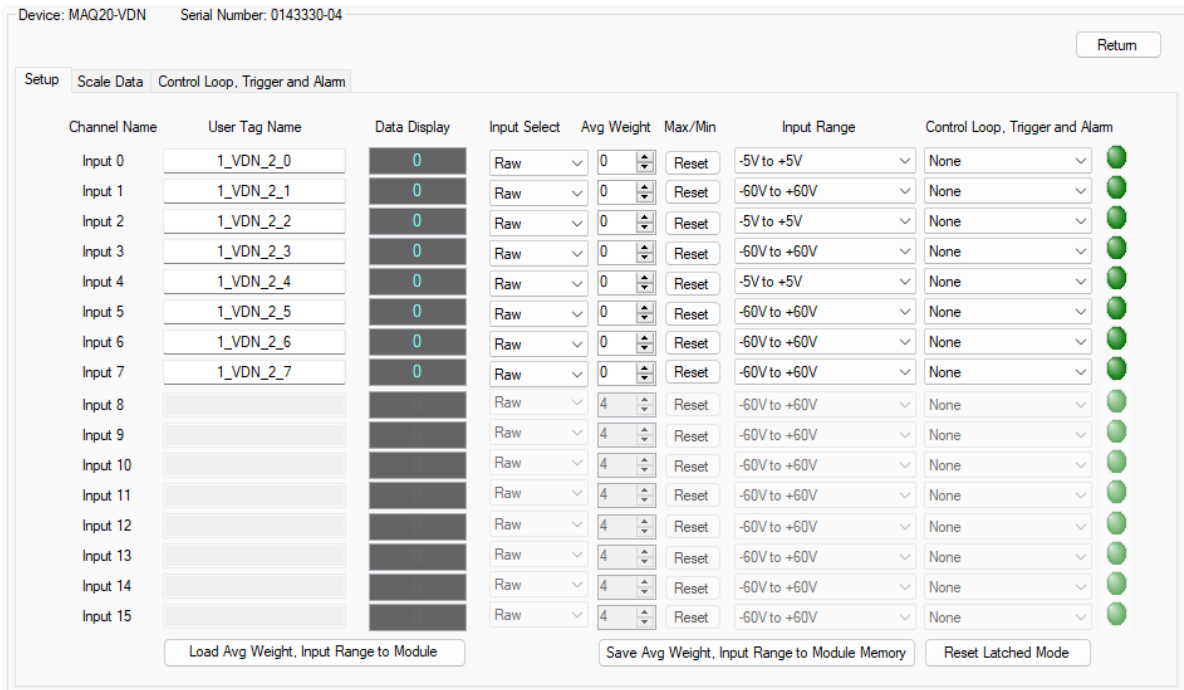

Each channel can have a unique User Tag Name. The system automatically assigns the default tag name when the system is first connected. The format of the default tag name is:

system name \_ device name \_ slot number \_ channel number

For example, in the default name 1\_VDN\_2\_0:

- 1 = System 1
- VDN = MAQ20-VDN module
- 2 = Module is in system Slot 2
- 0 = MAQ20-VDN channel 0

To change the tag name, enter the new name in the User Tag Name text box for the channel. References to this channel in other panels will use this entered tag name.

Current, Average, Maximum, or Minimum data for each channel can be displayed based on selection. Click on the Select selection box and choose the desired data.

Average Weight can be set independently for each channel. Use the Avg Weight selection box to set the desired value.

To reset the Maximum and Minimum value, click on the reset button of the channel.

Input Range can be set independently for each channel. Use the Input Range selection box to set the desired value. The data scale also automatically reset when the input range changed. Accuracy of MAQ®20 modules are specified as percent of span; selecting the smallest input range for a given channel will produce more accurate readings.

Control Loop or Alarm Output function for a given analog input channel is configured by selecting the desired function from the selection box. Alarms can be Tracking or Latched with High, Low, High-Low, High-High, Low-Low, or High-High Low-Low limits. Alarm limit values are set using the Control Loop / Alarm Output tab.

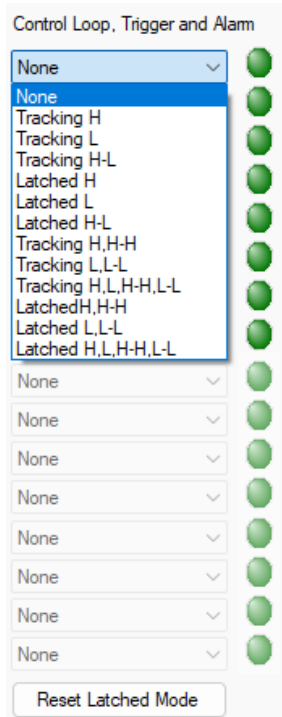

Alarms can be reset with the Reset Latched Mode Alarm button or by assigning reset function to a Button Tool in the user project.

- **Scale Data tab:**

Channel Name	Full Scale	Scale To		Unit
Input 0	-4016 to 4016 Count	-5	5	V
Input 1	-4016 to 4016 Count	-60	60	V
Input 2	-4016 to 4016 Count	-5	5	V
Input 3	-4016 to 4016 Count	-60	60	V
Input 4	-4016 to 4016 Count	-5	5	V
Input 5	-4016 to 4016 Count	-60	60	V
Input 6	-4016 to 4016 Count	-60	60	V
Input 7	-4016 to 4016 Count	-60	60	V
Input 8	-4016 to 4016 Count	0	0	
Input 9	-4016 to 4016 Count	0	0	
Input 10	-4016 to 4016 Count	0	0	
Input 11	-4016 to 4016 Count	0	0	
Input 12	-4016 to 4016 Count	0	0	
Input 13	-4016 to 4016 Count	0	0	
Input 14	-4016 to 4016 Count	0	0	
Input 15	-4016 to 4016 Count	0	0	

The MAQ®20 analog input values have 12-bit resolution plus sign, which equates to a full-scale range of -4016 to 4016 counts. This count range can be scaled to any engineering units on a per-channel basis. By default, the analog input channels are scaled to the selected input range. For example, if an input range of -5V to +5V is selected for a given channel, then collected data for that channel is automatically scaled to -5V and +5V.

Analog input data in counts always represents the full range of the signal applied to input channel. How this data maps to actual engineering units depends the internal mapping of the signal range to counts and the scale setting chosen.

*Example:*

Channel 0 is connected to a sensor which outputs 0V to +5V to represent 0 to 120 MPH.

Data from channel 0 of a MAQ20-VDN input module is read.

Channel 0 input range set to -5V to +5V.

A data value of 0x0000 (0V) corresponds to an input of 0 MPH.

A data value of 0x0FB0 (+5V) corresponds to an input of 120MPH.

To scale the 0 to +5V input range to a linear representation of the 0 to 120MPH input range, enter the data shown below:

Channel Name	Full Scale	Scale To		Unit
Input 0	-4016 to 4016 Count	-120	120	MPH



- Control Loop / Alarm tab:

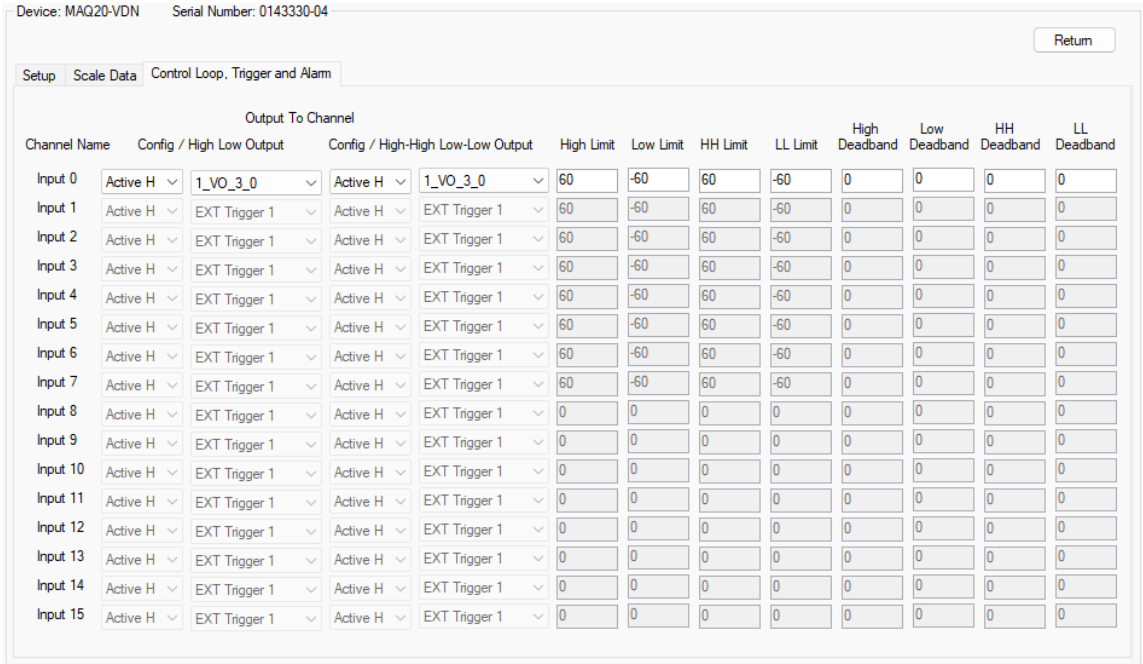

The Control Loop / Alarm tab provides a simple interface to select control loop or alarm output states of High, Low, High-High, or Low-Low, as well as to configure the output active states and set the alarm limits and dead-band. The Control Loop and Alarm outputs can be mapped to Discrete Output channels, and/or to Analog Output channels.

To use the Control Loop or Alarm Output function:

1. Select the Control Loop or Alarm Output mode for analog input channels in the Setup tab.

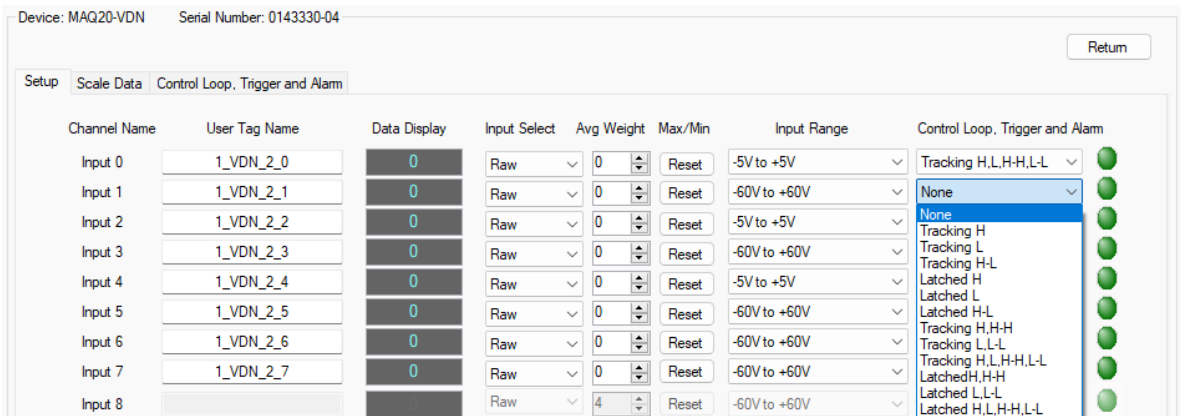

- Configure the channel Control Loop or Alarm Output active state, Discrete Output and/or Analog Output mapped channel, Alarm Limits, and Deadband parameters in the Control Loop / Alarm Output selection box.

Channel Name	Config / High Low Output	Config / High-High Low-Low Output	High Limit	Low Limit	HH Limit	LL Limit	High Deadband	Low Deadband	HH Deadband	LL Deadband		
Input 0	Active H	1_VO_3_0	Active H	1_VO_3_0	60	-60	60	-60	2	0	2	0
Input 1	Active H	EXT Trigger 1	Active H	EXT Trigger 1	60	-60	60	-60	0	0	0	0

### 3.4 Analog Output Modules

The Analog Output Module configuration panel has two tabs [Setup] and [Scale Data] that provide a simple interface to configure and write data to analog output modules such as MAQ20-VO and -IO. To open the analog output module configuration panel, click on the output module graphic in the system representation.

- Setup Tab:**

Channel Name	User Tag Name	Output Data	Project Data	Output Range	Output Default	Project Default
Output 0	1_VO_3_0	0	0	-10V to 10V	0	0
Output 1	1_VO_3_1	0	0	-10V to 10V	0	0
Output 2	1_VO_3_2	0	0	-10V to 10V	0	0
Output 3	1_VO_3_3	0	0	-10V to 10V	0	0
Output 4	1_VO_3_4	0	0	-10V to 10V	0	0
Output 5	1_VO_3_5	0	0	-10V to 10V	0	0
Output 6	1_VO_3_6	0	0	-10V to 10V	0	0
Output 7	1_VO_3_7	0	0	-10V to 10V	0	0

Buttons: Save Default Output / Range to EEPROM, Load and Set the Output Defaults

Each channel can have a unique User Tag Name. The system automatically assigns the default tag name when the system is first connected. The format of the default tag name is:

system \_ device name \_ slot number \_ channel number

For example, in the default name 1\_VO\_3\_0

1 = System 1

VO = MAQ20-VO module

3 = module is in system Slot 3

0 = MAQ20-VO channel 0

To change the tag name, enter the new name in the User Tag Name text box for the desired channel. References to this channel in other panels will use this entered tag name.

Data entered in the Output Data box will be written to the analog output channels when the project execution is started.

Default Output Data are user defined values which are the known safe analog output values in case of loss of communication from the host or accidental power cycling of the MAQ®20 Data Acquisition System.

Default output values are applied to the analog output channels when:

- System power is turned on.
- ReDAQ® Shape Software for MAQ®20 is stopped.
- Communications between the host computer and the hardware are lost.

**To set the default outputs, enter the desired value into the Default Output Data box, then click on the [Save Default Output / Range to EEPROM] button.**

Buffer Scan Mode is used to output a specified data sequence to the output channels. To configure the buffer mode, ensure the active project is stopped, select Buffer Scan Mode, and set the output interval between data point writes in milliseconds. Program the output data for each of the channels by entering the data into the Buffer Mode Output Data text box, or load the data from a text file.

Data points must be comma delimited. The last character in a sequence indicates how the data is to be output. If the last value is the character 'S', the output scan will stop upon completion of the specified sequence. If the last value is the character 'R', the output scan will loop back to the starting point and continue to run the specified sequence until manually stopped by the user.

Output data format:

Value 1, Value 2, Value 3,...,Value n, S → Output the data sequence once, then stop.  
Value 1, Value 2, Value 3,...,Value n, R → Output the data sequence continuously.

Example 1:

Analog output range set to 0V to +5V

Data = [0,1,2,3,4,5,R]

A stair step-up waveform will be output continuously.

Example 2:

Analog output range set to 0V to +5V

Data = [5,4,3,2,1,0,S]

A stair step-down, one shot waveform will be output.

To save or retrieve the programmed output data from the host computer, click on the [Save Burst Output Data to File] or [Load Burst Output Data from File] button.

- **Scale Data tab:**

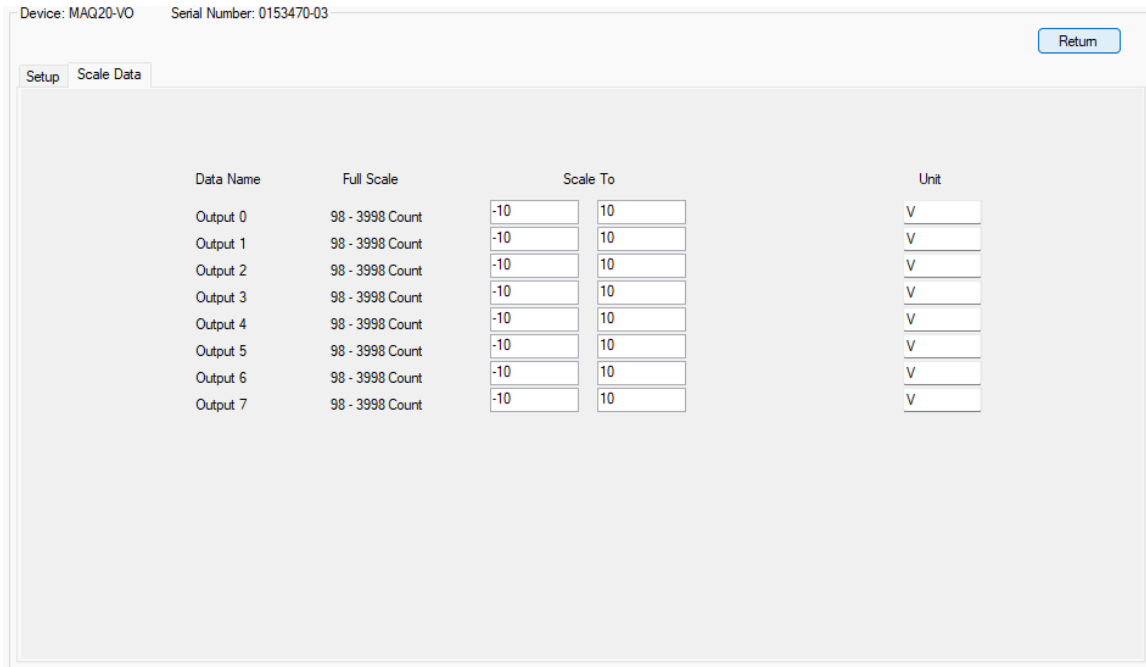

MAQ®20 analog output data values have 12-bit resolution, which equates to a full-scale range input of 98 to 3998 counts. This count range can be scaled to any engineering units on a per-channel basis. The default output range for the voltage output module is -10V to +10V and the default scale factor is 1, which yields an output range of -10V to +10V. This mapping can be changed using the scale factor.

*Example:*

A voltage output module is configured for -10V to +10V output range.

Data in counts is written to Channel 0.

A data value of 0x0062 corresponds to an output of -10V.

A data value of 0x0F9E corresponds to an output of +10V.

To scale the -10V to +10V output range to a linear representation of a -100°C to +300°C output range, enter the data shown below:

Data Name	Full Scale	Scale To		Unit
Output 0	98 - 3998 Count	-100	300	C

### 3.5 Discrete Input-Output Module

The Discrete Input-Output configuration panel has four tabs [Setup], [Special Function], [Special Functions I/O Map for DIO L], and [Special Functions I/O Map for DIO H] which provide a simple interface to configure and operate the Discrete I/O Channels and Special Functions. To open the discrete input-output module configuration panel, click on the DIO module graphic in the system representation.

• **Setup tab:**

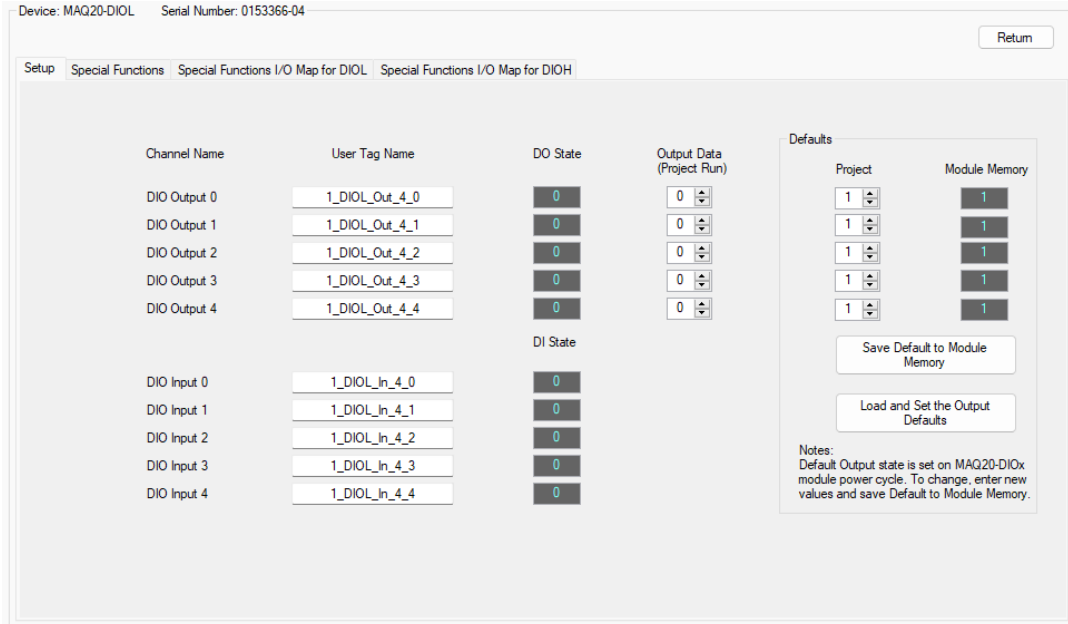

Each channel can have a unique User Tag Name. The system automatically assigns the default tag name when the system is first connected. The format of the default tag name is:

system \_ device name \_ slot number \_ channel number

For example, in the default name 1\_DIOL\_Out\_4\_0

- 1 = System 1
- DIOL = MAQ20-DIOL module
- Out = Discrete Output Channel
- 4 = module is in system Slot 4
- 0 = MAQ20-DIO channel 0

To change the tag name, enter the new name in the User Tag Name text box for the desired channel. References to this channel in other panels will use this tag name.

The user can view discrete input data in the DIO Status data display boxes and write discrete output data by entering a value of 0 or 1 in the Output Data boxes.

Default Output Data and Default DIO States are user defined values which are the known safe discrete output values in case of loss of communication from the host or accidental power cycling of the MAQ®20.

Default output values are applied to the discrete output channels when:

- System power is turned on.
- ReDAQ® Shape Software for MAQ®20 is stopped.
- Communications between the host computer and the hardware are lost.

To set the default outputs, enter the desired value into the Default Output Data box and then click on the [Save Default to Module Memory] button.

- **Special Function tab:**

Device: MAQ20-DIOL    Serial Number: 0153366-04 Return

Setup   Special Functions   Special Functions I/O Map for DIOL   Special Functions I/O Map for DIOH

	Pulse/Frequency Counter	Counter With Debounce	Waveform Measurement	Time Between Events	Frequency Generator	PWM Generation	One-Shot Pulse
<b>Timer 0</b>	Internal Trigger Disabled ▾	External Enable Positive Edge ▾	Active Low ▾	Pulse Count 0    Reset	Frequency Count 0	Ticks per Revolution 1	RPM 0
<b>Timer 1</b>	Internal Trigger Disabled ▾	External Enable Positive Edge ▾	Active Low ▾	Pulse Count 0    Reset	Frequency Count 0	Ticks per Revolution 1	RPM 0

Save Settings to Module Memory  
Load Settings From Module Memory

To configure the Discrete I/O Special Functions, first ensure the active project is stopped. The Discrete Input-Output channels do not need to be configured or set with initial I/O states because ReDAQ® Shape Software for MAQ®20 will do this automatically when a particular Special Function is chosen.

*Example 1:*

Frequency Generator:

- Select the [Frequency Generator] function button in the Timer 0 block.
- Enter the desired output frequency.
- Set the Disabled/Enabled/Button Tool Trigger state to Enabled in the Timer 0 dropdown menu.
- Click the Start button.

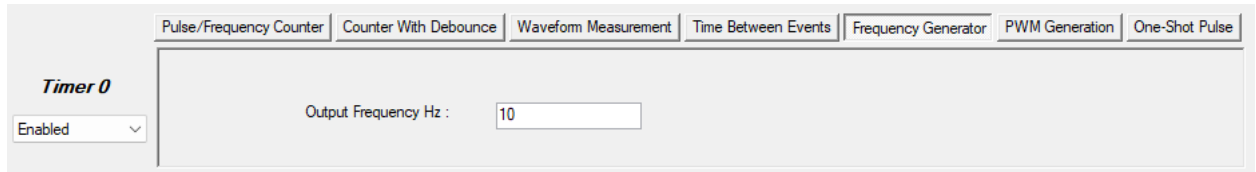

*Example 2:*

Pulse/Frequency Counter:

- Select the [Pulse/Frequency Counter] function button in the Timer 1 block.
- Enter Input Polarity, Timer Gate, and Ticks per Revolution.
- Set the Disabled/Enabled/Button Tool Trigger state to Enabled in the Timer 1 dropdown menu.
- Using the Toolbox, insert a Button and Numeric Edit box on the Present panel.
- Double-click on the Button and Numeric Edit box to open the properties for each and connect them to the Pulse/Frequency/Counter special function.
- Click the start button.



- The Button will start and stop the function and the Numeric Edit box will display the frequency.

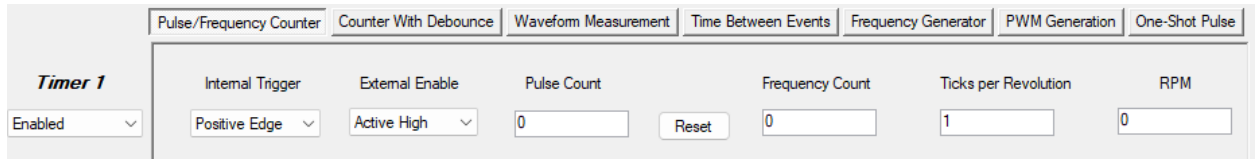

• **Special Functions I/O Map for DIOL Tab:**

Device: MAQ20-DIOL Serial Number: 0153366-04

Return

Setup Special Functions Special Functions I/O Map for DIOL Special Functions I/O Map for DIOH

Special Function Number	Special Function Description	Channel Type	Channel Function	Channel Assignment for Special Functions using Timer	Channel Assignment for Special Functions using Timer	Available Alarms for Special Functions using Timer 0	Available Alarms for Special Functions using Timer 1
1	Pulse / Frequency Counter	Input	Input Signal	DI0	DI2	High Low. Alarm can be mapped to DI0.	High Low. Alarm can be mapped to DI02.
		Input	External Enable	DI1	DI3	High-High Low-Low. Alarm can be mapped to DI01.	High-High Low-Low. Alarm can be mapped to DI03.
2	Pulse / Frequency Counter w/Debounce	Input	Input Signal	DI0	DI2	High Low. Alarm cannot be mapped to DI0.	High Low. Alarm cannot be mapped to DI02.
		Output	Debounced Version of Input Signal	DO0	DO2	High-High Low-Low. Alarm can be mapped to DI01.	High-High Low-Low. Alarm can be mapped to DI03.
3	Waveform Measurement	Input	Input Signal	DI0	DI2	High Low. Alarm can be mapped to DI0.	High Low. Alarm cannot be mapped to DI02.
		Input	Input Signal 1	DI0	DI2	High-High Low-Low. Alarm can be mapped to DI01.	High-High Low-Low. Alarm can be mapped to DI03.
4	Time Between Events	Input	Input Signal 1	DI0	DI2	High Low. Alarm can be mapped to DI0.	High Low. Alarm cannot be mapped to DI02.
		Input	Input Signal 2	DI1	DI3	High-High Low-Low. Alarm can be mapped to DI01.	High-High Low-Low. Alarm can be mapped to DI03.
5	Frequency Generator	Output	Output Signal	DO0	DO2		
6	PVM Generator	Output	Output Signal 1	DO0	DO2		
		Output	Output Signal 2	DO1	DO3		
7	One-Shot Pulse Generator	Output	Output Signal	DO0	DO2		
		Input	Trigger	DI0	DI2		

The Special Functions I/O Map for DIOL tab provides information on special function configurations and channel properties specific to the -DIOL module.

• **Special Functions I/O Map for DIOH Tab:**

Device: MAQ20-DIOL Serial Number: 0153366-04

Return

Setup Special Functions Special Functions I/O Map for DIOL Special Functions I/O Map for DIOH

Special Function Number	Special Function Description	Channel Type	Channel Function	Channel Assignment for Special Functions using Timer 0	Channel Assignment for Special Functions using Timer 1
1	Event Counter	Input	Input Signal	DI0	DI2
		Input	External Enable	DI1	DI3
2	Time Between Events	Input	Input Signal 1	DI0	DI2
		Input	Input Signal 2	DI1	DI3

The Special Functions I/O Map for DIOH tab provides information on special function configurations and channel properties specific to the -DIOH module.



## 4.0 Test, Process, and Analyze Data in Analyze Panel

### 4.1 Analyze Panel

The Analyze panel has four tabs to test, process, and analyze data from the MAQ®20 Data Acquisition System without any programming.

- View Raw Data
- View Analog Input/Output Channels
- View Discrete DIO Channels
- Read / Write Modbus Registers

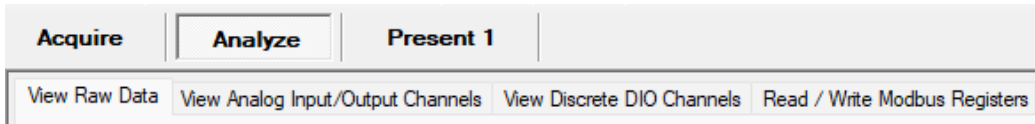

Once communications with the system have been configured and established, the tools on the Analyze panel can be used at any time by pressing the Start button.



The Analyze panel can be shown or hidden by making the appropriate selection from the View pull-down menu.

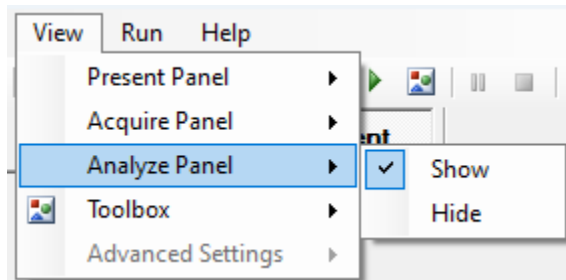

## 4.2 View Raw Data

The View Raw Data tab shows data read from all analog and discrete input/output channels on the MAQ®20 Data Acquisition System regardless of whether they are configured. Data is time stamped and the display is continuously updated while the system is running. Data can be saved to a text or Excel file on the host computer for storage or later processing.

The screenshot displays the 'View Raw Data' window. At the top, there are tabs for 'View Analog Input/Output Channels', 'View Discrete DIO Channels', and 'Read / Write Modbus Registers'. Below the tabs, there is a 'Save to file' dropdown menu, a 'Data Save Mode' dropdown set to 'Over Write', and a text box showing the file path: 'C:\Users\MAQ20\_TEST\_D1\Documents\Dataforth\MAQ20\ReDAQ Shape MAQ20\Data.txt'. There are also buttons for 'Grid display with unit', 'Copy to Clipboard', 'Delete Rows Data', 'Delete All Data', 'History Capacity: 1000', 'Change File Name', 'Open Data File', and 'Open Excel File'.

On the left side, there is a 'Select Channel' section with 'Select All' and 'Clear All' buttons. A list of channels is shown with checkboxes, including 1\_VDN\_2\_2, 1\_VDN\_2\_3, 1\_VDN\_2\_4, 1\_VDN\_2\_5, 1\_VDN\_2\_6, 1\_VDN\_2\_7, 1\_VO\_3\_0, 1\_VO\_3\_1, 1\_VO\_3\_2, 1\_VO\_3\_3, 1\_VO\_3\_4, 1\_VO\_3\_5, 1\_VO\_3\_6, 1\_VO\_3\_7, and 1\_DIO\_Out\_4\_0. Below this is a 'Select Trigger' dropdown menu set to 'Manual'.

The main data grid has the following columns: Samples\_Time, 1\_VDN\_2\_0, 1\_VDN\_2\_1, 1\_VDN\_2\_2, 1\_VDN\_2\_3, 1\_VDN\_2\_4, 1\_VDN\_2\_5, 1\_VDN\_2\_6, and 1\_VDN\_2\_7. The first row is highlighted in blue and contains the date '3/22/2023' and addresses for each channel. Subsequent rows show time-stamped data for each channel, such as '09:07:36.969' and voltage values like '1.103V'.

Samples_Time	1_VDN_2_0	1_VDN_2_1	1_VDN_2_2	1_VDN_2_3	1_VDN_2_4	1_VDN_2_5	1_VDN_2_6	1_VDN_2_7
Date: 3/22/2023	Addr:5000	Addr:5001	Addr:5002	Addr:5003	Addr:5004	Addr:5005	Addr:5006	Addr:5007
1_09:07:36.969	1.103V	1.599V	1.606V	1.599V	0.021V	0.015V	0.015V	0.015V
2_09:07:36.085	1.104V	1.584V	1.604V	1.599V	0.021V	0.015V	0.015V	-0.015V
3_09:07:36.189	1.104V	1.599V	1.604V	1.599V	0.021V	0.03V	0.015V	0.03V
4_09:07:36.304	1.103V	1.584V	1.602V	1.599V	0.02V	0.03V	0.03V	0.015V
5_09:07:36.429	1.103V	1.584V	1.602V	1.599V	0.02V	0.03V	0.03V	0.015V
6_09:07:36.587	1.104V	1.599V	1.604V	1.599V	0.02V	0.015V	0.045V	0V
7_09:07:36.745	1.104V	1.599V	1.604V	1.599V	0.02V	0.03V	0.03V	-0.015V
8_09:07:36.935	1.104V	1.599V	1.602V	1.599V	0.02V	0.045V	0.015V	-0.015V
9_09:07:37.140	1.104V	1.584V	1.605V	1.584V	0.02V	0.015V	0.015V	-0.015V
10_09:07:37.345	1.103V	1.599V	1.604V	1.584V	0.02V	0.015V	0.015V	-0.015V
11_09:07:37.585	1.103V	1.599V	1.604V	1.599V	0.021V	0.015V	0.03V	0.03V
12_09:07:37.837	1.104V	1.599V	1.606V	1.584V	0.02V	0.015V	0.03V	-0.015V
13_09:07:38.104	1.104V	1.599V	1.604V	1.599V	0.02V	0.015V	0.015V	-0.015V
14_09:07:38.390	1.106V	1.599V	1.604V	1.599V	0.021V	0.03V	0.015V	0V
15_09:07:38.690	1.103V	1.599V	1.602V	1.599V	0.02V	0.03V	0.015V	-0.015V
16_09:07:39.006	1.103V	1.614V	1.605V	1.599V	0.02V	0.015V	0.015V	-0.015V
17_09:07:39.370	1.104V	1.599V	1.605V	1.584V	0.021V	0.045V	0.015V	0.03V
18_09:07:39.733	1.104V	1.584V	1.604V	1.584V	0.02V	0.03V	0.03V	0V

- To save collected data to a file on the host computer, select 'Save to file' from the drop-down selection box. This will save raw data to a text file without units. Select 'Save to file with unit' if it is desired to have units on the collected data saved to the text file. Text file size is only limited by the host computer hard drive available space. The rate at which data is logged is set by the system sampling interval.
- The grid display can show data with or without units or can be disabled using the selection box.
- The filename and path for the logged data file is shown in the box at the top of the panel. Use the [Change File Name] button to select a new filename. Standard MS Windows naming convention applies.
- The Data Save Mode selection box allows the choice of saved data modes of Over Write, Append, Auto File Increment, or Continue.
- The text file displayed in the box at the top of the panel can be opened using the [Open Data File] button.
- To copy data to another application, first select the rows of data in spreadsheet or click the box at the top left corner of the grid to select all rows, then click on the [Copy to Clipboard] button. The data is now in the clipboard and can be pasted into other software applications which accept data in space delimited .txt format.
- To delete data from the grid display, select the row or rows of data to be deleted and click on the [Delete Rows Data] button.
- To delete all data in the grid display, click on the [Delete All Data] button.
- The limit for data shown in the grid display and in the graphs on the View Analog Input Channels tab and View Discrete I/O Channels tabs is set using the History Capacity box. The default setting is 1000. Once the limit is reached, data will be cleared from the grid display and graphs and will start over from 1.

### 4.3 View Analog Input Channels

The View Analog Input Channels tab provides graphical views of acquired data. Seven different modes are available for optimal data display:

- Fixed
- AutoScaleLoose
- AutoScaleExact
- ScopeChart
- StripChart
- AutoScaleVisibleLoose
- AutoScaleVisibleExact

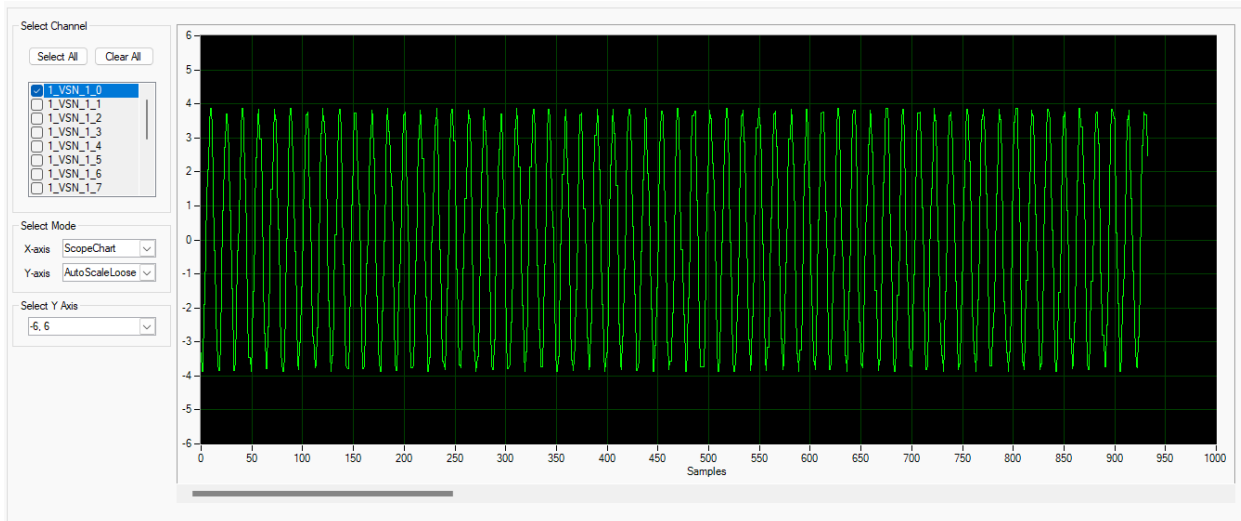

- Analog input channels displayed on the graph are enabled using the Channel Select checkboxes.
- X and Y axis limits can be set using the pull-down boxes.

#### 4.4 View Discrete I/O Channels Tab

The View Discrete I/O Channels tab provides a graphical view of the data for the five discrete input and output channels on the MAQ20-DIOx module. Data can be displayed or hidden using the +/- box at the top left corner of the plot. The horizontal hash mark in the left-hand legend represents the midscale value for each channel for determination of channel low/high state.

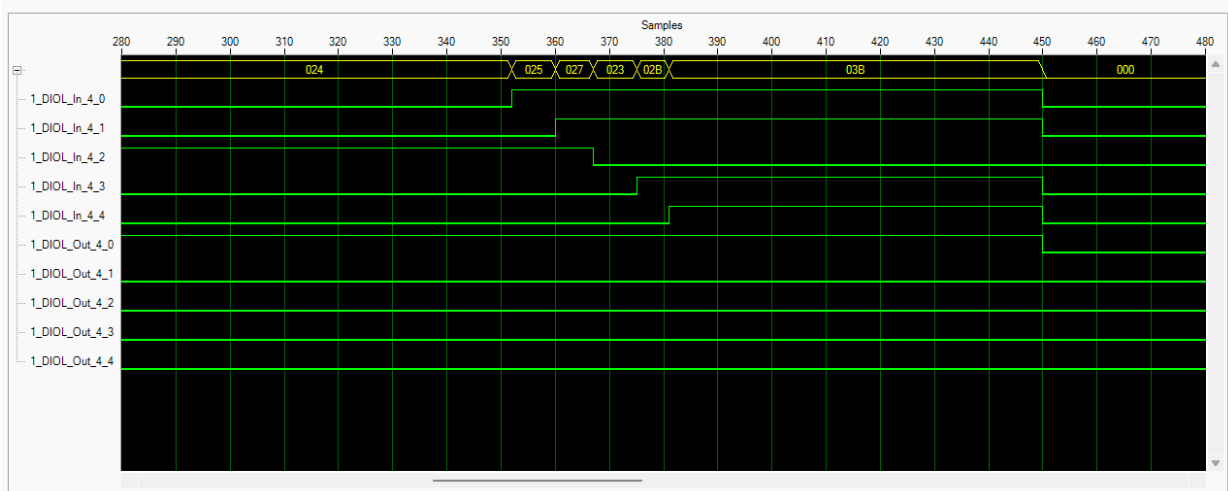

### 4.5 Read / Write Modbus Registers

The Read / Write Modbus Registers tab provides a simple interface to directly read and write any Modbus register in the system. Through this interface, the user can setup, configure, test, and operate the MAQ®20 data acquisition system. The Read function can read up to 40 registers at once and the Write function can write to 20 registers at once.

For detailed information on the MAQ®20 Modbus commands, refer to MAQ®20 Hardware User Manuals specific to each module type.

**Read Modbus Registers**

System 1  Start address  QTY

0 - 9	<input type="text" value="0"/>	<input type="text" value="0"/>	<input type="text" value="0"/>	<input type="text" value="0"/>	<input type="text" value="0"/>	<input type="text" value="0"/>	<input type="text" value="0"/>	<input type="text" value="0"/>	<input type="text" value="0"/>	<input type="text" value="0"/>
10 - 19	<input type="text" value="0"/>	<input type="text" value="0"/>	<input type="text" value="0"/>	<input type="text" value="0"/>	<input type="text" value="0"/>	<input type="text" value="0"/>	<input type="text" value="0"/>	<input type="text" value="0"/>	<input type="text" value="0"/>	<input type="text" value="0"/>
20 - 29	<input type="text" value="0"/>	<input type="text" value="0"/>	<input type="text" value="0"/>	<input type="text" value="0"/>	<input type="text" value="0"/>	<input type="text" value="0"/>	<input type="text" value="0"/>	<input type="text" value="0"/>	<input type="text" value="0"/>	<input type="text" value="0"/>
30 - 39	<input type="text" value="0"/>	<input type="text" value="0"/>	<input type="text" value="0"/>	<input type="text" value="0"/>	<input type="text" value="0"/>	<input type="text" value="0"/>	<input type="text" value="0"/>	<input type="text" value="0"/>	<input type="text" value="0"/>	<input type="text" value="0"/>

**Write Modbus Registers**

System 1  Start address  QTY

0 - 9	<input type="text" value="0"/>	<input type="text" value="0"/>	<input type="text" value="0"/>	<input type="text" value="0"/>	<input type="text" value="0"/>	<input type="text" value="0"/>	<input type="text" value="0"/>	<input type="text" value="0"/>	<input type="text" value="0"/>	<input type="text" value="0"/>
10 - 19	<input type="text" value="0"/>	<input type="text" value="0"/>	<input type="text" value="0"/>	<input type="text" value="0"/>	<input type="text" value="0"/>	<input type="text" value="0"/>	<input type="text" value="0"/>	<input type="text" value="0"/>	<input type="text" value="0"/>	<input type="text" value="0"/>

To Read from the Modbus registers:

- Enter the Start Address to read from and the quantity of addresses to read.
- Click on the [Read] button.
- If the project is running, current data will be displayed each time the [Read] button is pressed. If the project is stopped, the last contents of the register will be displayed.
- Data displayed is the decimal value of the ASCII character.

To write to the Modbus registers:

- Enter the Start Address to write to and quantity of addresses to write.
- Enter the data to write using the text boxes. In each box, enter the decimal value of the ASCII character.
- Click on the [Write] button.

## 5.0 Create User Interfaces and Edit Tools in the Present Panel

### 5.1 Present Panel

The Present panels allow the user to create up to 20 separate displays to interface to a MAQ®20 Data Acquisition System, all of which can run simultaneously. Examples of interfaces include instrument panels, indicators, graphical displays for data monitoring, buttons for control, control loops, and alarms for processes. Panels are added and removed using the View drop-down menu. Displays and Tools are added using the Toolbox and can be resized, moved, cut, copied, pasted, and deleted. Once an interface is developed, it is saved to a project file. Properties of the displays, Tools, and Present panel can be modified by double clicking on the item.

The graphic below shows an example of a Present panel which has been set up with a custom background and a dial gauge to display scaled data from an analog input channel.

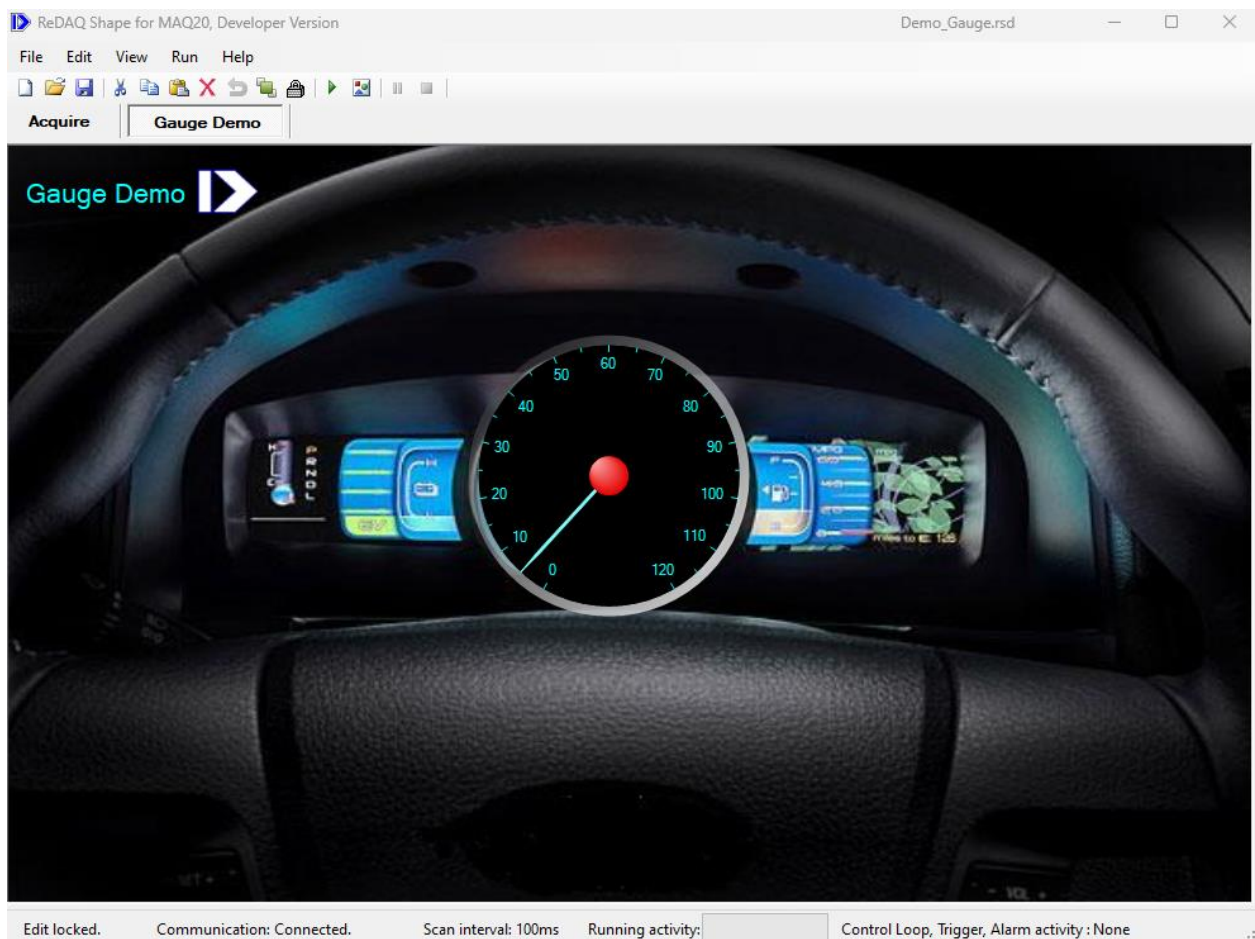

To start editing in a Present panel, first verify the Edit: Lock/Unlock status on the bottom left corner of the panel.

**Edit: Unlocked.**

To lock or unlock Panel editing, click on the Lock/Unlock button on the toolbar.  or select Edit Lock/Unlock from the Edit pull-down menu.

Present panel appearance can be customized for a given application. Plant schematic drawings, images, or pictures can be used as background and the panel name can be changed.

To setup the properties of Present panel, double click on a blank area in the panel and the Present panel Properties window will appear.

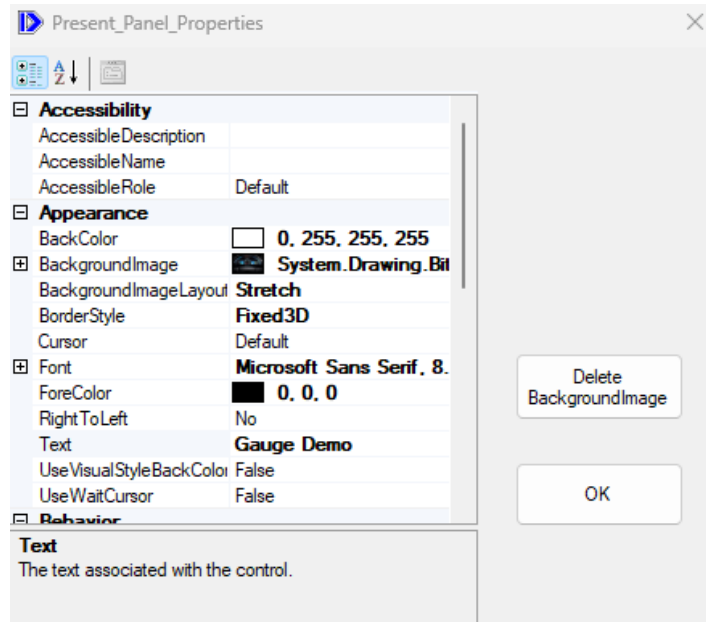

There are seven categories in the Present panel properties:

- Accessibility
- Appearance
- Behavior
- Data
- Focus
- Layout
- Miscellaneous

Only Appearance properties can be changed. All others are fixed.

The Present panel name is found in the Text field and can be changed by highlighting the field and entering the desired text. Font and foreground colors are configured using the appropriate fields.

A custom background image can be loaded by clicking on the background image box and selecting the image from the host computer. All common image formats are accepted. Background image variable parameters are none, tile, center, stretch, or zoom. To delete the background image, click on the Delete Backgroundimage] button.

## 5.2 Toolbox Usage

The Toolbox contains 18 different Tools, many of which have several different styles. To open or close the toolbox window, click on the toolbox icon, or select Toolbox from the View pull-down menu.

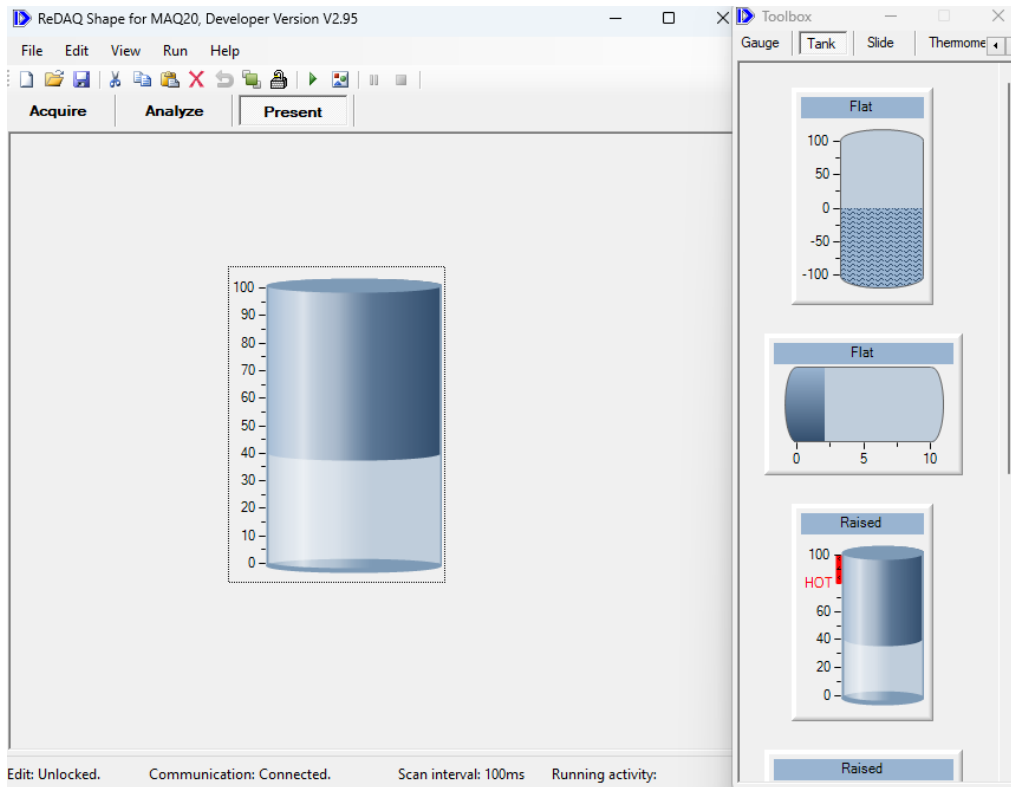

To select different tools, use the tools scroll bar at the top of the window.

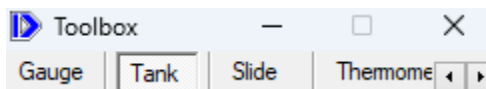

To select a Tool, click on the image of the Tool and it will be highlighted.

To add a Tool on the Present panel, position the mouse pointer on Present panel location where the tool is to be placed, click the left mouse button to place the tool, hold the mouse button and drag to establish the desired size of the Tool.

To reposition the Tool, click and hold the left mouse button on the Tool and drag it to the desired position.

To resize the Tool, click and hold the right mouse button on the Tool and drag to the desired size.

To setup the Tool properties, double click on the Tool and edit the appropriate fields in the properties window.

To cut, copy, paste, or delete a Tool, select the Tool by clicking on it, then click on the Cut, Copy, Paste or Delete icons at the top of the window or select Cut, Copy, Paste or Delete from the Edit pull-down menu.



### 5.3 Toolbox Tools

The Toolbox contains 18 different Tools, many of which have several different styles. To open or close the toolbox window, click on the toolbox icon, or select Toolbox from the View pull-down menu.

ReDAQ® Shape Software for MAQ®20 offers 18 different types of Tools for building applications:

The Graph group contains:

- Chart Recorder
- Scope
- XY plot
- Discrete Waveform Graph

The Knob group contains:

- 5 styles of Knobs

The Meter group contains:

- 4 styles of Meters

The Gauge group contains:

- 6 styles of Gauges

The Tank group contains:

- 6 styles of Tanks

The Slide group contains:

- 6 styles of Slides

The Thermometer group contains:

- 6 styles of Thermometers

The NumericEdit group contains:

- 4 styles of Numeric Edit

The Switch group contains:

- 14 styles of Pushbutton, Slide, Rocker, and Toggle Switches

The LED group contains:

- 4 styles of LED

The Other Tools group contains:

- Label
- Group Box
- Picture Box
- Text Box

These Tools are based on Controls found in Microsoft Visual Studio or National Instrument's Measurement Studio™. If more detailed information is required on the Control properties, refer to the appropriate Microsoft or National Instruments User Manuals.

Each project created within the ReDAQ® Shape Software for MAQ®20 can have up to 12 Tools with high level functions, inclusive of (Chart Recorder, Scope, XY Plot and Discrete Waveform Graph) and up to 40 Tools of all other types.

All the Tools can easily be selected from the Toolbox and inserted into a project. From there they can be moved, resized, cut, copied, pasted, or deleted using simple point and click operations. Double clicking on a given Tool will open the properties window for the Tool where detailed settings can be changed.

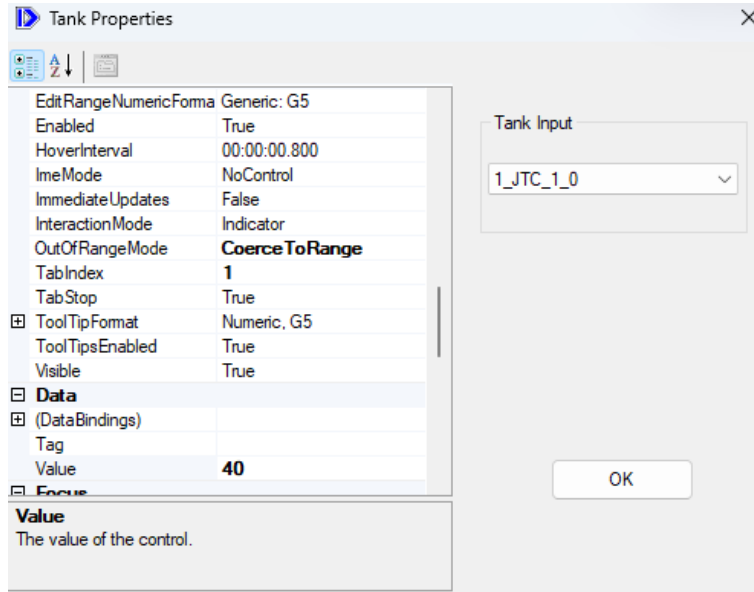

The Properties window for a Tool is separated into two parts:

The left pane of the property window is where detailed properties such as background, name, font, style, color, scale, and layout can be modified. The right pane has a pull-down selection box where inputs or outputs for the Tool are selected. Some of the Tools, such as Picture Box, Text Box, Group Box, and Label do not have an input/output select box in their property window because they are used only as graphic or text displays.

In the example shown above, the pull-down selection box will show the following default tag names:

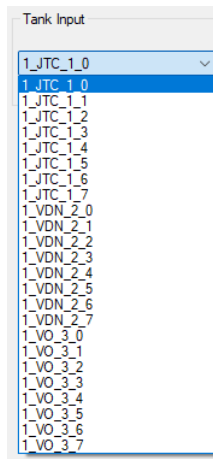

If 1\_VDN\_2\_0 is selected for the input to the Tank Tool shown above, the tank will display the System 1 MAQ20-VDN module analog input channel 0.

If the default tag names are changed, the new tag names will appear in the Tool properties window.

### 5.3.1 Chart Recorder Tool

The Chart Recorder Tool displays data from analog input channels in the MAQ®20 Data Acquisition System. Data can be displayed from multiple channels in multiple modules simultaneously.

To change the Chart Recorder Tool properties, double click on the Chart Recorder to open the Properties window. Only the Appearance, Behavior, Graph, and Layout categories contain parameters that are useful to modify when interfacing to the MAQ®20 Data Acquisition System.

- Choose the analog input channels to display in the Chart Recorder Tool by using the checkboxes in the Channel Select area of the Properties window.

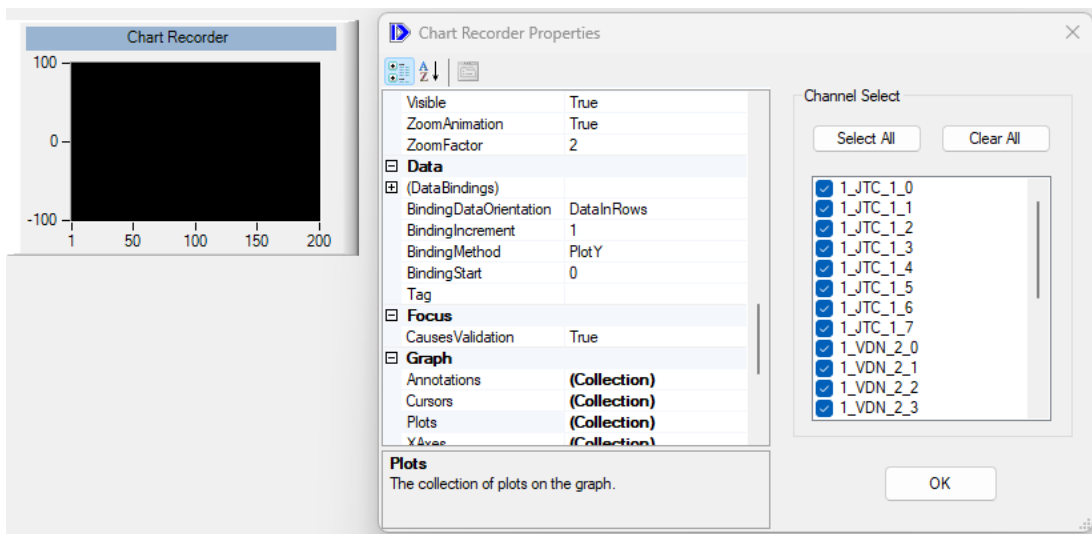

### 5.3.2 Scope Tool

The Scope Tool displays data from analog input channels in the MAQ®20 Data Acquisition System. Data can be displayed from multiple channels of multiple modules simultaneously.

To change the Scope Tool properties, double click on the scope to open the Properties window. Only the Appearance, Behavior, Graph, and Layout categories contain parameters that are useful to modify when interfacing to the MAQ®20 Data Acquisition System.

- Choose the analog input channels to display in the Scope Tool by using the checkboxes in the Channel Select area of the Properties window.

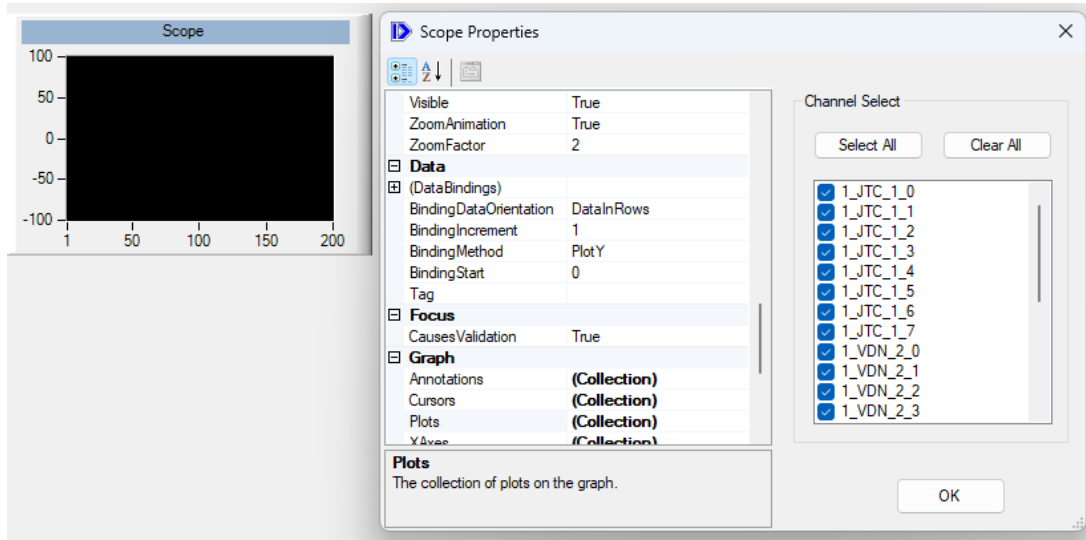

### 5.3.3 XY Plot Tool

The XY Plot Tool can display data from analog input channels in the MAQ®20 Data Acquisition System. Any channel can be chosen for the X-axis and Y-axis. The number of samples to display can be specified. Once the number of samples to display has been exceeded, the display will refresh and the prior data will be erased.

To change the XY Plot Tool properties, double click on the plot to open the Properties window. Only the Appearance, Behavior, Layout and Scale categories contain parameters that are useful to modify when interfacing to the MAQ®20 Data Acquisition System.

- Assign the analog input channel for the X-axis of the display in the XY Plot Tool by using the X CH Select pull-down selection box.
- Assign the analog input channel for the Y-axis of the display in the XY Plot Tool by using the Y CH Select pull-down selection box.
- Specify the number of samples to display in the XY Plot Tool before refresh by entering the number in the Plot Samples box.

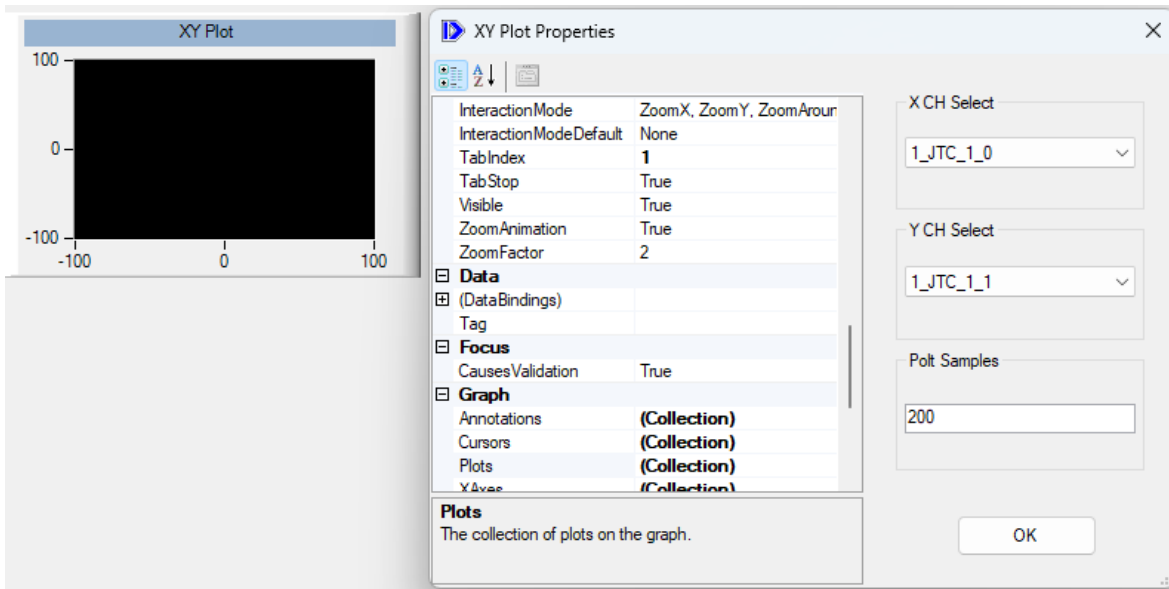

### 5.3.4 Discrete Waveform Graph Tool

The Discrete Waveform Graph Tool displays the data for discrete input channels in the MAQ®20 Data Acquisition system. The X-axis represents the number of samples collected from the system and is shown at the top of the display and the Y axis shows the logic states 0 or 1 for the channels. Data can be displayed or hidden using the +/- box at the top left corner of the plot. The horizontal hash mark in the left-hand legend represents the midscale value for each channel for determination of channel low/high state.

To change the Discrete Waveform Graph Tool properties, double click on the device to open the Properties window. Only the Appearance, Graph, Layout, and Scroll Bar categories contain parameters that are useful to modify when interfacing to the MAQ®20.

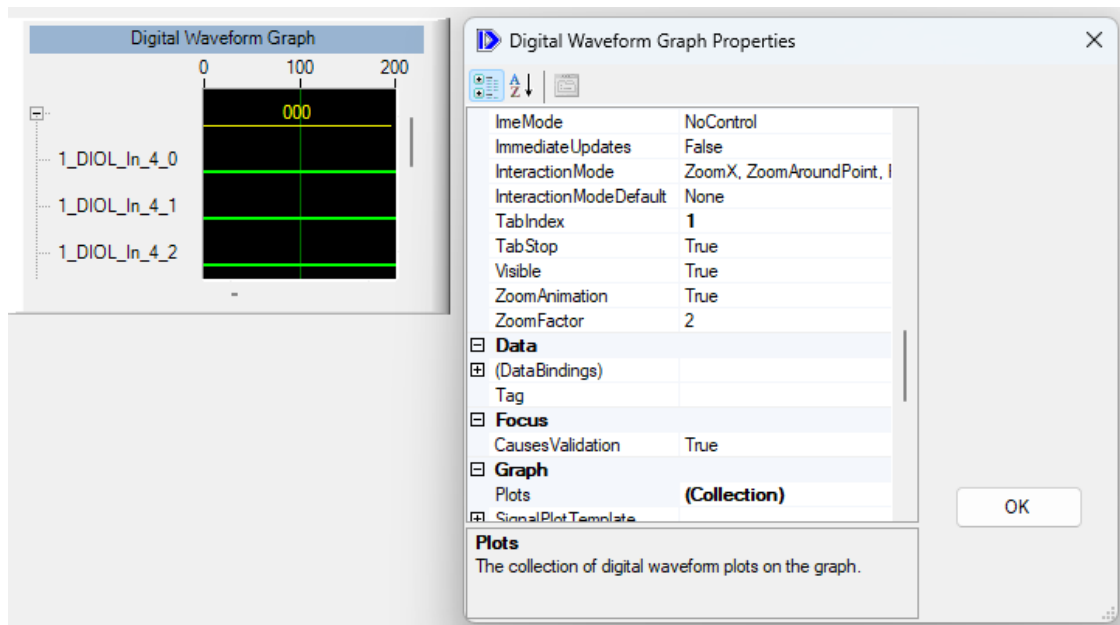

### 5.3.5 Knob Tool

The Knob Tool outputs data to analog output channels in the MAQ®20 Data Acquisition System.

To change the Knob Tool properties, double click on the knob to open the Properties window. Only the Appearance, Behavior, Layout, and Scale categories contain parameters that are useful to modify when interfacing to the MAQ®20 Data Acquisition System.

- Assign the analog output channel to send data to with the Knob Tool by using the Knob Output pull-down selection box.

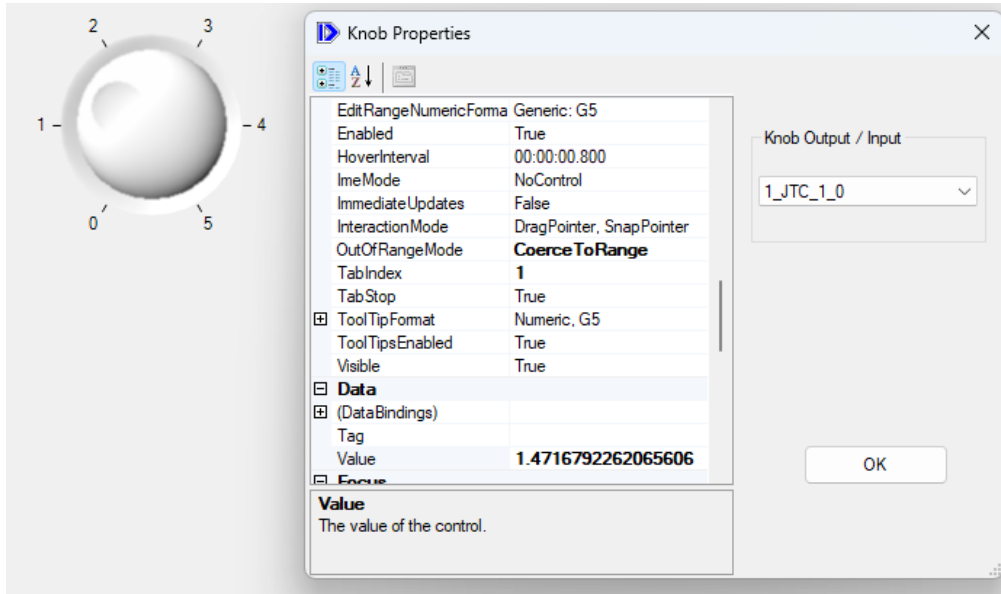

### 5.3.6 Meter Tool

The Meter Tool displays data from analog input channels in the MAQ®20 Data Acquisition System.

To change the Meter Tool properties, double click on the Meter Tool to open the Properties window. Only the Appearance, Behavior, Layout, and Scale categories contain parameters that are useful to modify when interfacing to the MAQ®20 Data Acquisition System.

- Assign the analog input channel to display in the Meter Tool by using the Meter Input pull-down selection box.

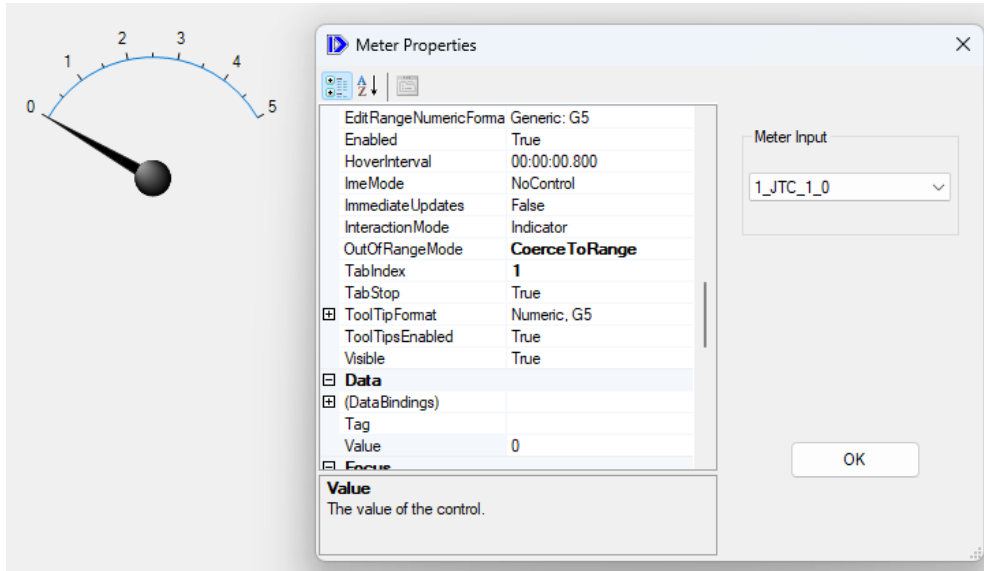



### 5.3.7 Gauge Tool

The Gauge Tool displays data from analog input channels in the MAQ®20 Data Acquisition System.

To change the Gauge Tool properties, double click on the Gauge Tool to open the Properties window. Only the Appearance, Behavior, Layout, and Scale categories contain parameters that are useful to modify when interfacing to the MAQ®20.

- Assign the analog input channel to display in the Gauge Tool by using the Gauge Input pull-down selection box.

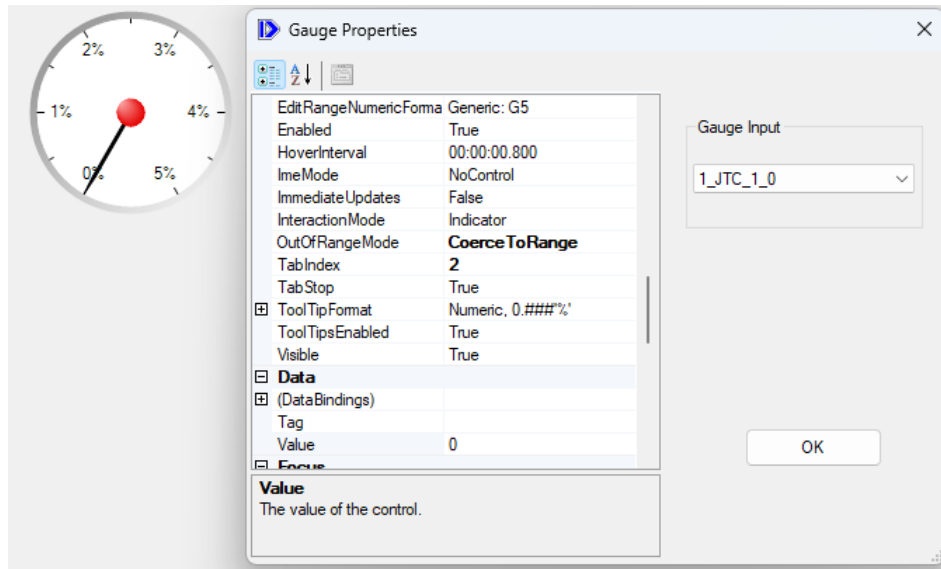

### 5.3.8 Tank Tool

The Tank Tool displays data from analog input channels in the MAQ®20 Data Acquisition System.

To change the Tank Tool properties, double click on the Tank Tool to open the Properties window. Only the Appearance, Behavior, Layout, and Scale categories contain parameters that are useful to modify when interfacing to the MAQ®20 Data Acquisition System.

- Assign the analog input channel to display in the Tank Tool by using the Tank Input pull-down selection box.

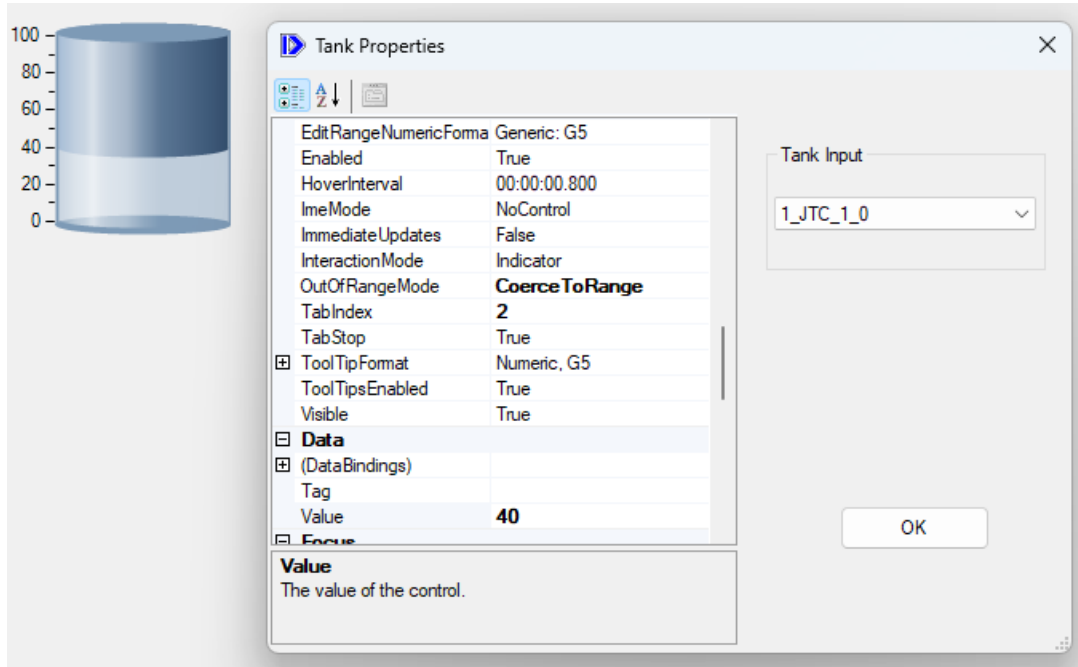

### 5.3.9 Slide Tool

The Slide Tool performs both input and output functions for analog I/O channels in the MAQ®20 Data Acquisition System. If an analog input channel is assigned to the Tool, the slide position represents the analog input channel reading. If an analog output channel is assigned to the Tool, moving the slide will generate a scaled output to the assigned analog output channel.

To change the Slide Tool properties, double click on the Slide Tool to open the Properties window. Only the Appearance, Behavior, Layout, and Scale categories contain parameters that are useful to modify when interfacing to the MAQ®20 Data Acquisition System.

- Assign the analog I/O channel to in the Slide Tool by using the Slide Input/Output pull-down selection box.

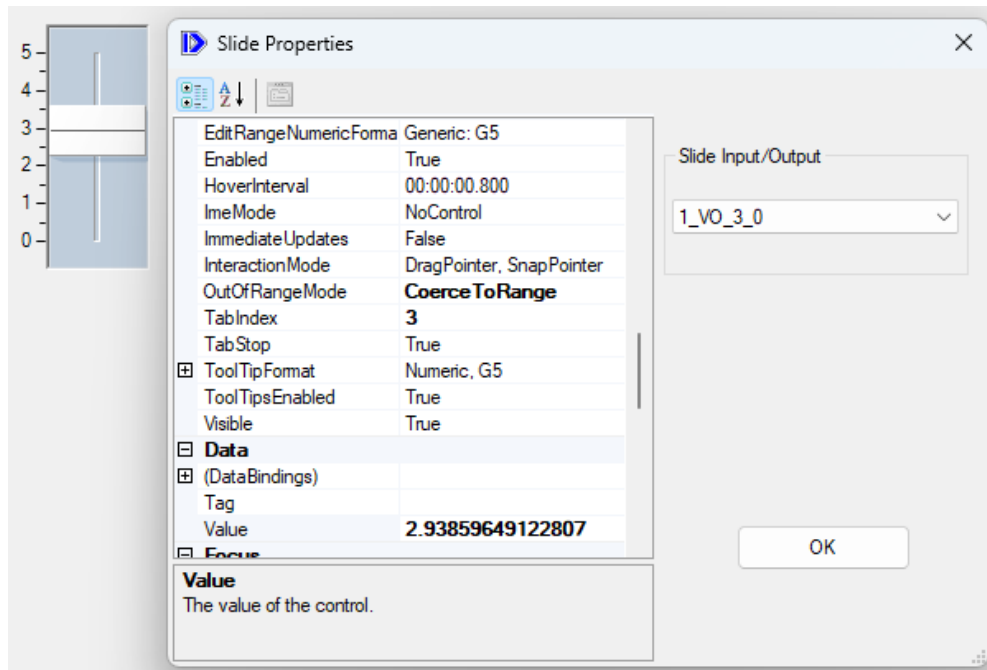

### 5.3.10 Thermometer Tool

The Thermometer Tool displays data from analog input channels in the MAQ®20 Data Acquisition System.

To change the Thermometer Tool properties, double click on the Thermometer to open the Properties window. Only the Appearance, Behavior, Layout, and Scale categories contain parameters that are useful to modify when interfacing to the MAQ®20.

- Assign the analog input channel to display in the Thermometer Tool by using the Thermometer Input pull-down selection box.

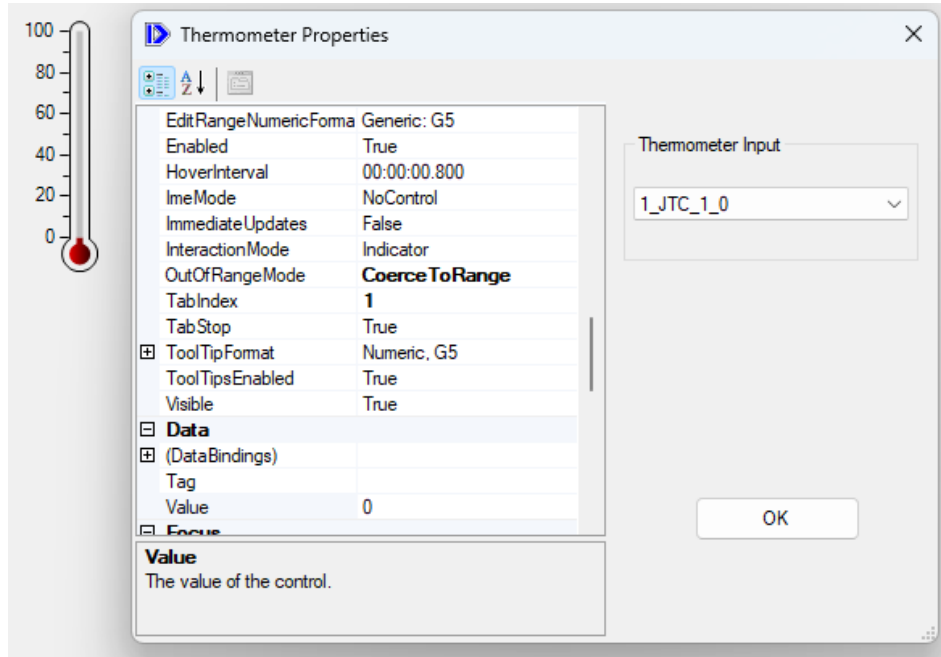

### 5.3.11 Numeric Edit Tool

The Numeric Edit Tool performs both input and output functions for analog I/O channels and for discrete I/O channel special functions in the MAQ®20 Data Acquisition System. If an analog input channel is assigned to the Tool, it will display the analog input channel reading. If an analog output channel is assigned to the Tool, data entered in the numeric edit box will be output to the assigned analog output channel. Another option is to assign the Numeric Input/Output to one of the discrete I/O channel special functions. Options are; Frequency, Pulse, Event, Duty Cycle, Period, Low Time, Width, Average, and Maximum or Minimum special functions either on Timer 0 or Timer 1. When this assignment is made, the Numeric Edit Tool will either display data from a special function such as frequency or counts, or can be used as input to a special function such as PWM Generation or One-Shot Pulse. For more information on discrete I/O special functions, refer to the MAQ®20 Hardware User Manual for the MAQ20-DIO module.

To change the Numeric Edit Tool properties, double click on the text field to open the Properties window. Only the Appearance, Layout, and Behavior, categories contain parameters that are useful to modify when interfacing to the MAQ®20.

A Numeric Edit Tool property of interest is FormatMode under the Behavior category. Clicking on this allows the user to change the numeric format to Binary, Engineering, Generic, Hexadecimal, Scientific, or SimpleDouble.

- Assign the analog I/O channel or discrete I/O channel special function to the Numeric Edit Tool using the Numeric Input/Output pull-down selection box.

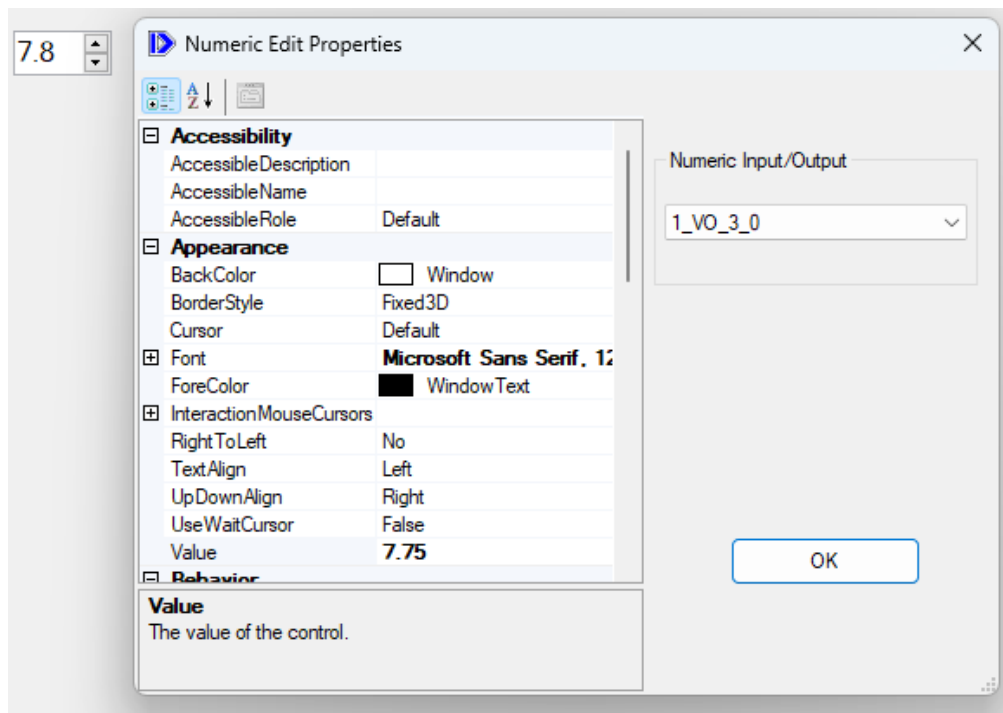

### 5.3.12 Switch Tool

The Switch Tool is a multiple output device that can have up to four outputs which can each be set up with the following functions:

- Set discrete output, channels, to 1 = On or 0 =Off.
- Set analog output channels to a preset, non-zero value of 1 = On or 0 = Off.

The Switch Tool can be configured to one of three Switch Types: On/Off, On Only, or Off Only.

For example, to use one switch as an On function and another as an Off function, set one as Switch Type On Only and the other as Switch Type Off Only, then connect them to the same discrete or analog output channel.

To change the Switch Tool properties, double click on the Switch to open the Properties window. Only the Appearance and Layout categories contain parameters that are useful to modify when interfacing to the MAQ®20 Data Acquisition System.

- A single Switch Tool can connect to up to four outputs. To select the Switch output function, first select Out 1 through Out 4, then choose the channel to Tool from the Switch Output selection box. The default setting is Out 1 set to DIO0 and Out 2, Out 3 and Out 4 set to Close.
- One of three button output types are selected using the Switch Type selection box.
- The preset the value to output from an Analog Output channel is entered into the Analog Output Value box. The default setting is 2.5V.

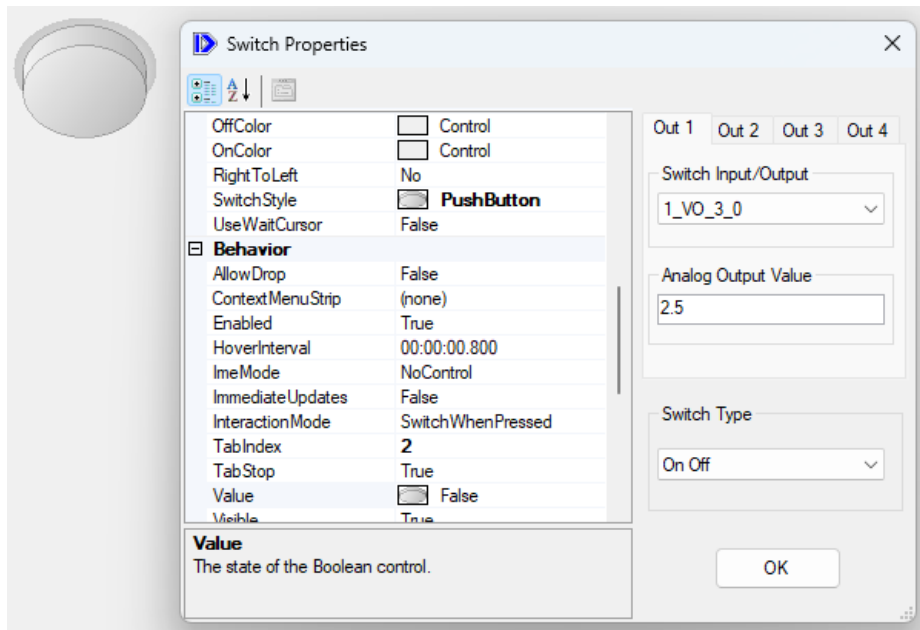

### 5.3.13 LED Tool

The LED indicator Tool can be used to monitor discrete input channels or analog input channels. A discrete input channel value of 1 turns the LED on and a value of 0 turns the LED off. An analog input channel value greater than a user selected preset value turns the LED on and a value less than the preset value turns the LED off. Multiple LED's can be connected to the same digital or analog input channel.

To use an LED in a project, select it from the Toolbox and place it on the Present panel. Select the input channel to monitor from the LED Input selection box. If the LED is to be assigned to an analog input channel, enter the preset value which represents the 'On' state in the Analog input on value box. To change the size, adjust the text font under the Font heading in the Properties box.

Double click on the LED to open the Properties box. Only the Appearance and Layout categories contain parameters that are useful to modify when interfacing to the MAQ®20 Data Acquisition System.

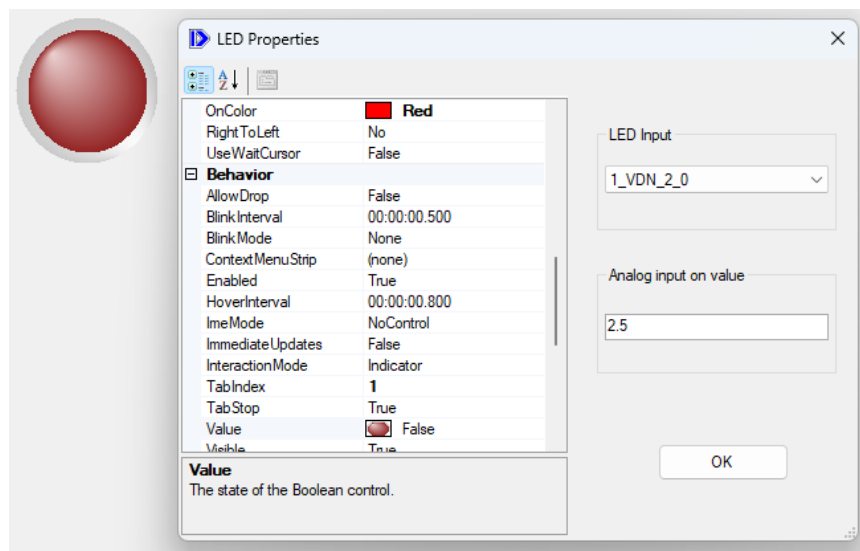

**Example 1:**

- Place three separate LED Tools on the Present panel.
- Connect the input for each of the three LEDs to analog input channel 1\_VDN\_1\_0.
- For LED #1, enter a preset AI on value of 1.0
- For LED #2, enter a preset AI on value of 2.0
- For LED #3, enter a preset AI on value of 3.0

As the input to channel 1\_VDN\_1\_0 increases, LED #1 will turn on when the 1\_VDN\_1\_0 reading exceeds 1.0V, LED #2 will turn on when the 1\_VDN\_1\_0 reading exceeds 2.0V, and LED #3 will turn on when the 1\_VDN\_1\_0 reading exceeds 3.0V.

As the input to channel 1\_VDN\_1\_0, LED #3 will turn off when the 1\_VDN\_1\_0 reading is equal to or less than 3.0V, LED #2 will turn off when the 1\_VDN\_1\_0 reading is equal to or less than 2.0V, and LED #1 will turn off when the 1\_VDN\_1\_0 reading is equal to or less than 1.0V.

### 5.3.14 Label Tool

The Label Tool allows creation of short text labels which can be placed anywhere on the Present panel to document, notate or clarify a project. To use a Label, select it from the Toolbox and place it on the Present panel. Default text for the Label is 'Label'. To modify this, double click the box to open the Properties box, then, under the Appearance heading and Text item, enter the desired text. The Label Tool cannot be resized by right clicking and dragging as for other Tools. To change the size, adjust the text font under the Font heading in the Properties box.

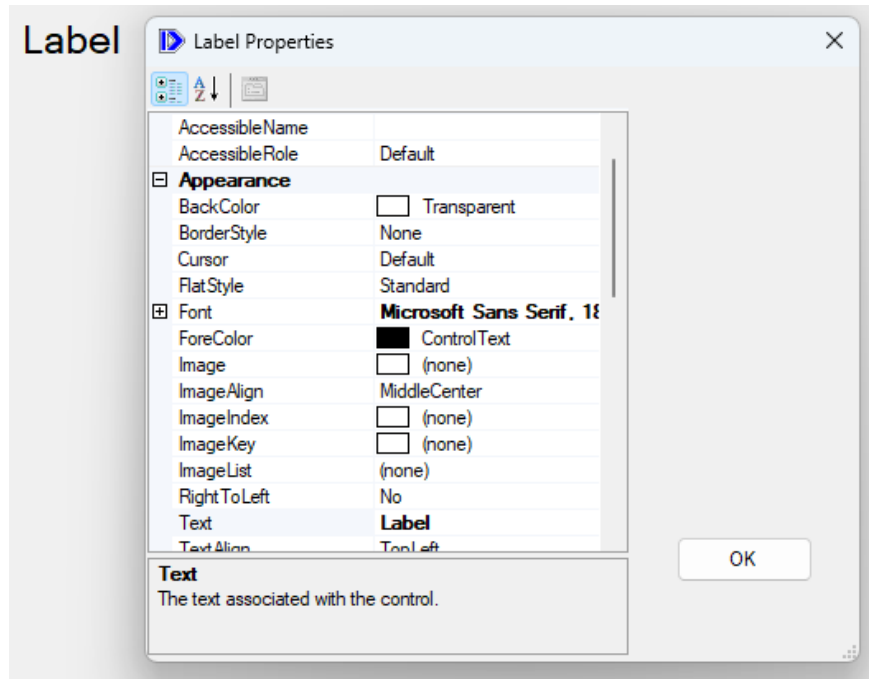



### 5.3.15 Group Box Tool

The Group Box Tool is used to draw a box around a group of Tools on the Present panel. It does not affect interaction between Tools or project execution. To use a Group Box, select it from the Toolbox and place it on the Present panel. Once placed, the box can be resized to encompass any of the Tools placed in a project. If desired, Group Box properties can be modified by double clicking the box and opening the Properties box.

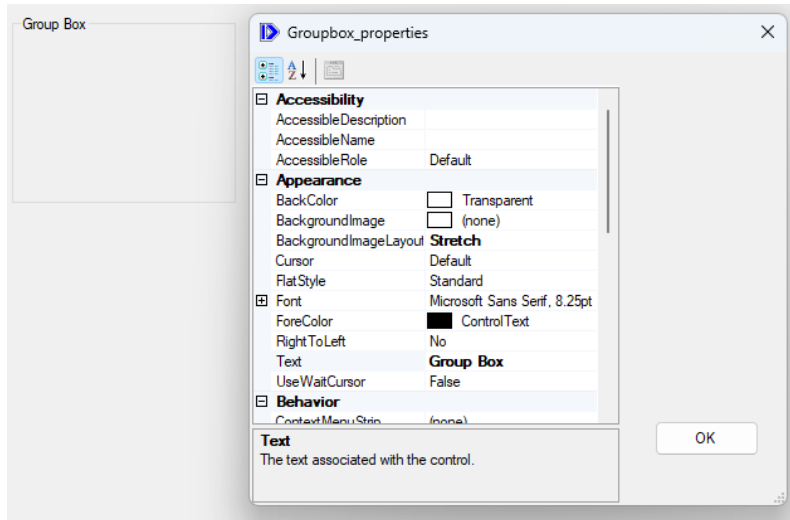

### 5.3.16 Picture Box Tool

The Picture Box Tool can be used to display any type of image file on the Present panel, including photographs of objects or graphs and plots. All common formats are supported. To open an image file, select the Picture Box Tool from the Toolbox and place it on the Present panel. Next, double click the item to open the Properties box. Image selection is made under the Appearance heading and Image item.

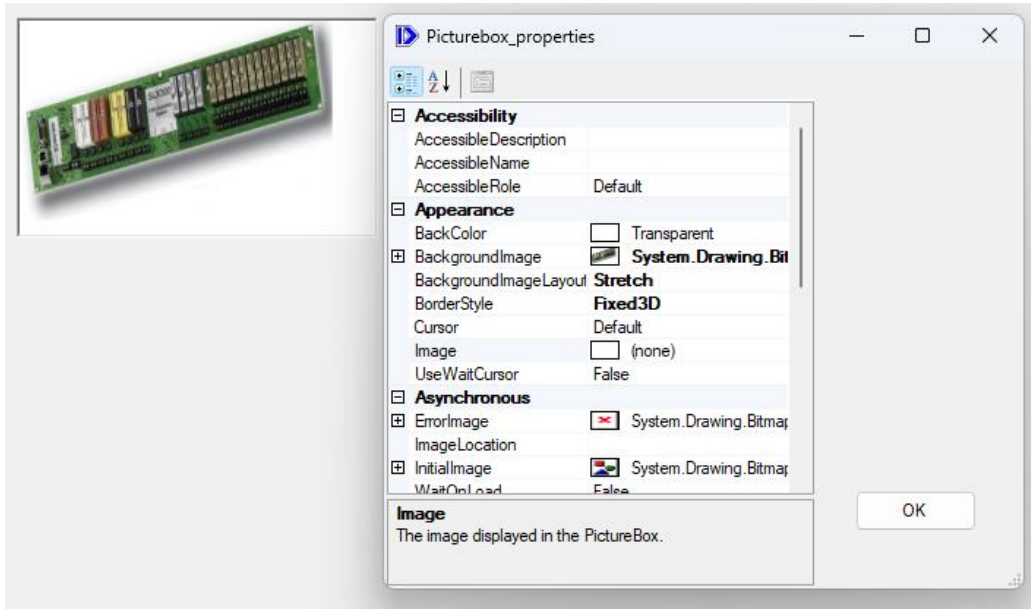

### 5.3.17 Text Box Tool

The Text Box Tool places a box on the Present panel where notes or instructions can be written. To use a Text Box, select it from the Toolbox and place it on the Present panel. Once placed, text can be added by placing the cursor in the Text Box and typing. If desired, Text Box properties can be modified by double clicking the box and opening the Properties box.

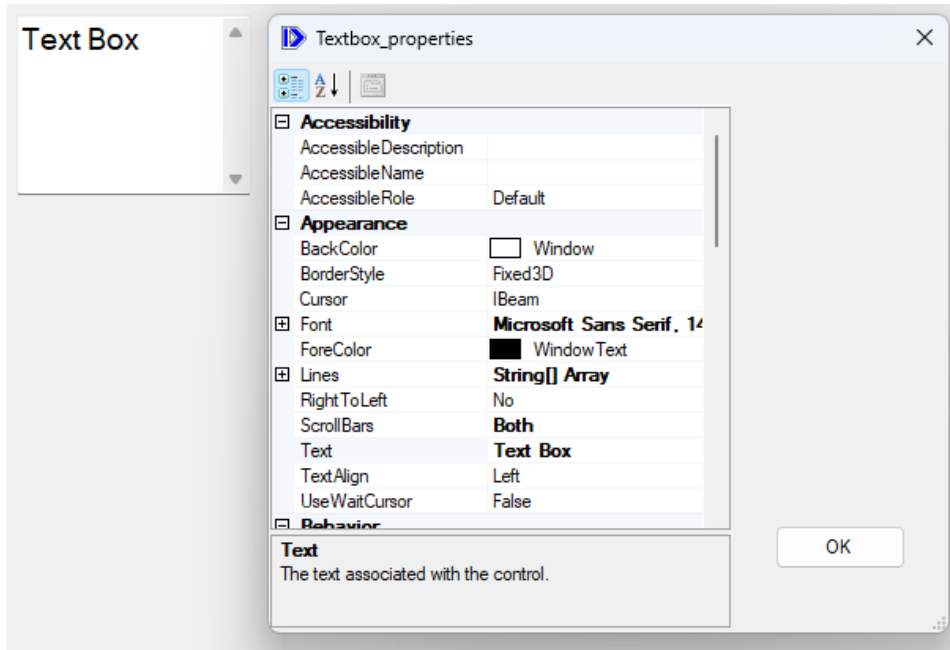

## 6.0 Quick Start Examples

### 6.1 Closed Loop Control

This closed loop control example demonstrates the implementation of a “bang-bang” temperature controller. It sets the temperature of a material to 75°C with a deadband of 2°C. The controller uses a discrete output channel to turn on a heater when the process first starts. When the temperature of the material reaches 75°C, the heater will turn off. Once the temperature cools down to 73°C, the heater will turn on again. As long as the process is running, the temperature “bang-bang” controller will keep the temperature of the material between 73°C and 75°C.

Step 1: Install a J-Type Thermocouple Input Module [MAQ20-JTC] configured with -100°C to +199°C input range in analog input channel 0, 1\_JTC\_1\_0, to monitor the temperature. Install a Discrete I/O Module [MAQ20-DIOL] for output.

Channel Name	User Tag Name	Data Display	Input Select	Avg Weight	Max/Min	Input Range	Control Loop, Trigger and Alarm
Input 0	1_JTC_1_0	0	Raw	0	Reset	-100 to 199°C	None
Input 1	1_JTC_1_1	0	Raw	0	Reset	-100 to 760°C	None
Input 2	1_JTC_1_2	0	Raw	0	Reset	-100 to 760°C	None

ReDAQ® Shape Software for the MAQ®20 Data Acquisition System will automatically set up the scale and units for the -JTC module on the Scale Data tab.

Channel Name	Full Scale	Scale To	Unit
Input 0	-2156 to 4290 Count	-100 199	°C
Input 1	-539 to 4095 Count	-100 760	°C
Input 2	-539 to 4095 Count	-100 760	°C

Step 2: On the Analyze Panel, Analog Input [AI] tab, set the Control Loop/Alarm Output to Tracking H (tracking mode and high alarm).

Channel Name	User Tag Name	Data Display	Input Select	Avg Weight	Max/Min	Input Range	Control Loop, Trigger and Alarm
Input 0	1_JTC_1_0	0	Raw	0	Reset	-100 to 199°C	Tracking H
Input 1	1_JTC_1_1	0	Raw				None
Input 2	1_JTC_1_2	0	Raw				None
Input 3	1_JTC_1_3	0	Raw				None
Input 4	1_JTC_1_4	0	Raw				None
Input 5	1_JTC_1_5	0	Raw				None
Input 6	1_JTC_1_6	0	Raw	0	Reset	-100 to 760°C	None

The software will jump to the Control Loop/Alarm Output tab to allow the output limit parameters to be set.

Step 3: In the Control Loop/Alarm Output tab, set the following parameters:

Config: Active L (Tool output active low)  
 Output to Channel 1\_DIOL\_Out\_4\_0 (Discrete output channel 0 controls the heater)  
 High Limit 75 (75°C high limit)  
 High Deadband 2 (2°C deadband)

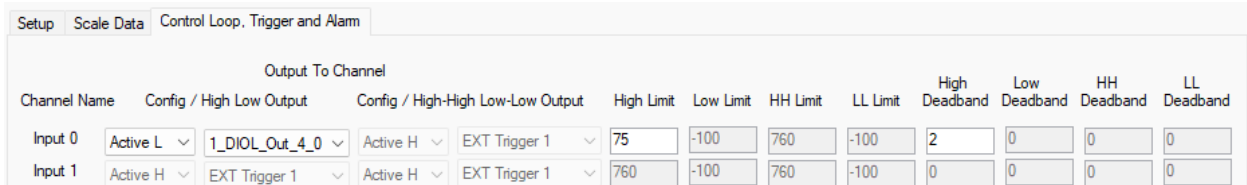

Step 4: Using the Present panel:

- Select a Thermometer Tool from the Toolbox to monitor the material temperature and place it on the panel. Open the Properties window of the Tool and set the range of the Tool to 0-100°C using the Scale category of the Properties window and assign analog input channel 1\_JTC\_1\_0 to the Tool using the Thermometer Input pull-down selection box.
- Select an LED Tool from the Toolbox to monitor the 1\_DIOL\_Out\_4\_0 output and place it on the panel. Open the Properties window of the Tool and enter the caption "Set: 75C" in the Appearance category.
- Select a Label Tool from the Toolbox to make a title for the project and place it on the panel. Open the Properties window of the Tool and enter "Example: A "bang-bang" temperature controller" in the Appearance category.

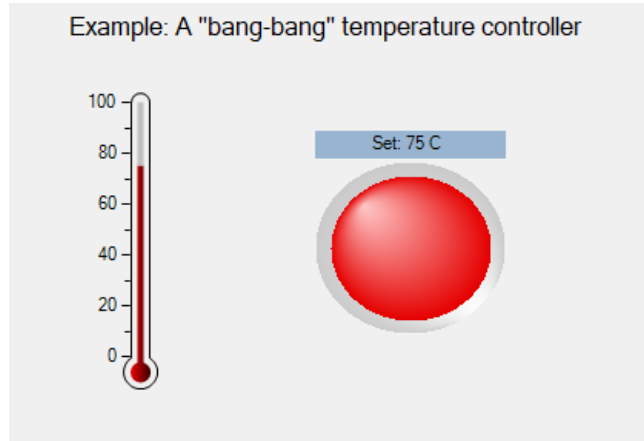

Step 5: Set up the Acquire panel Communications tab parameters to match the settings on the MAQ®20 Data Acquisition System and on the host computer. This includes System, Slave ID, choice of TCP/IP or Serial communications, IP address, Port Name, Baud Rate, and Parity.

Connect a J-Type thermocouple to channel 0 of the MAQ20-JTC module. Affix the thermocouple to the material for which the temperature is to be controlled. Connect the MAQ20-DIOL discrete output channel to an appropriate active low switch. Connect the switch and power to a heater. Place the heater in contact with the material. Check all connections, then click Start to run the controller.

## 6.2 PID – Tank Level Controller

ReDAQ® Shape Software for MAQ®20 provides a simple interface to the MAQ®20 Data Acquisition and Control System. An extensive toolbox in the software has a specialized PID Controller Faceplate as well as numerous buttons, switches, graphs, indicators, and other devices for controlling and monitoring a process.

The PID Controller provides real-time closed-loop control of industrial processes and equipment by comparing process output and setpoint values. The chosen PID algorithm then minimizes this error by adjusting the proportional (P), Integral (I), and Derivative (D) terms over time until the desired operating point is reached. The controller then maintains stable process operation over setpoint changes and process variations. The Noninteractive Control Algorithm is shown below and control algorithms are detailed in Section 7.2 of the MA1056 MAQ20 PID Controller User Manual.

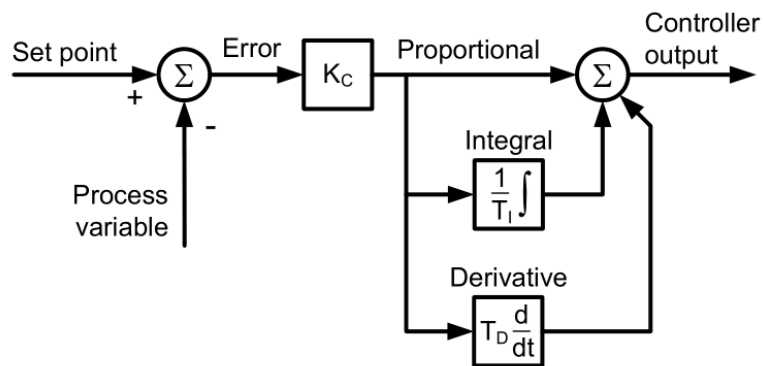

PID Control Using the Noninteractive Control Algorithm

A typical Level Control application which uses MAQ®20 hardware and ReDAQ® Shape Software for MAQ®20 is shown below. In this example, a MAQ20-IDN process current input module monitors the liquid level in the tank and provides the Process Variable (PV) while the MAQ20-IO current output module provides the Controller Output (CO).

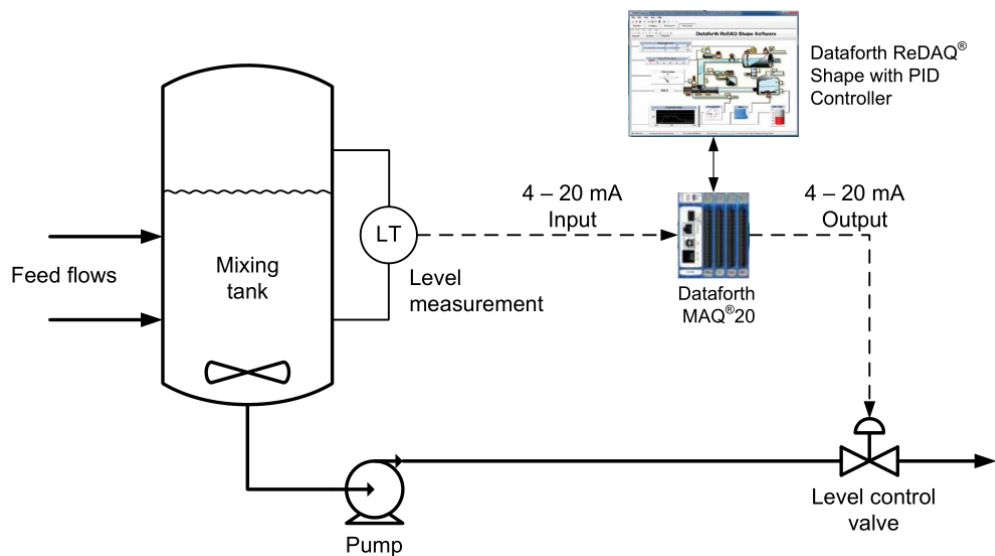

A powerful function integrated in the MAQ20-940 ReDAQ® Shape Software for MAQ®20 is an Auto-Tuner which is used to simplify the complex task of control loop tuning. To run the Auto-Tuner, first configure the system and the PID Controller. Next, Run the system and click the [Settings] button in the lower left corner of the PID Controller Faceplate.

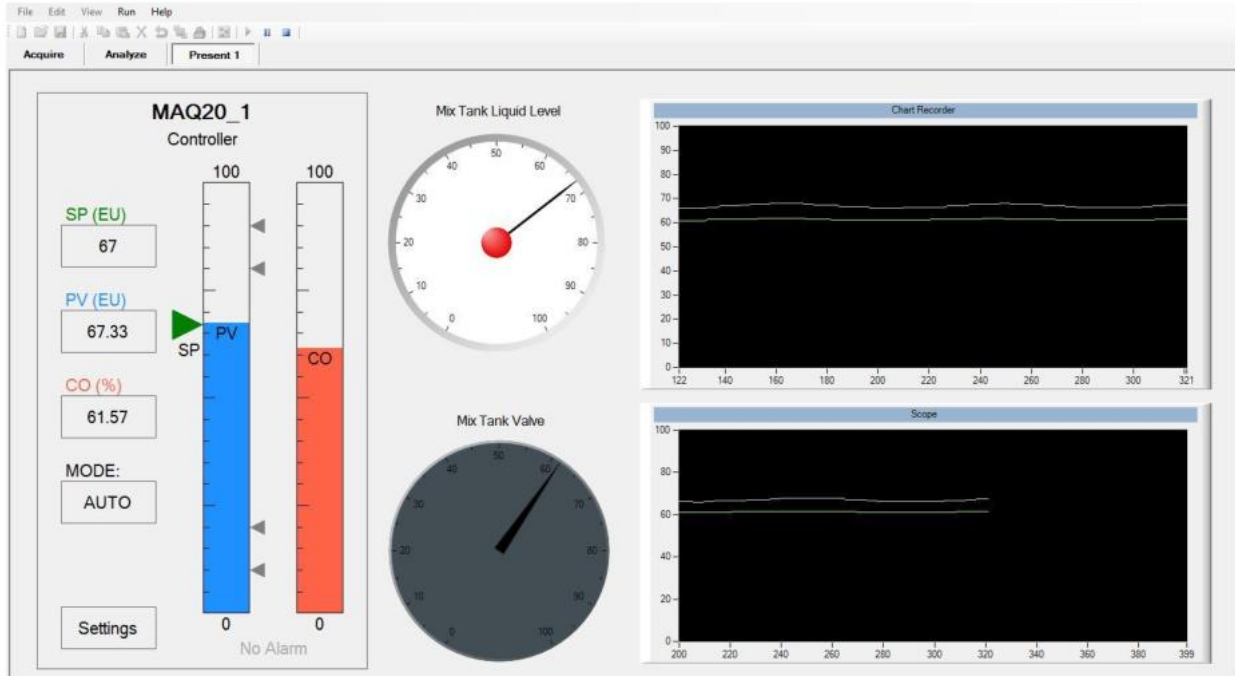

From the Basic Settings tab, click the [Auto Tune] button in the middle of the window. The PID Controller Auto-Tune interface will open as shown in the image below.

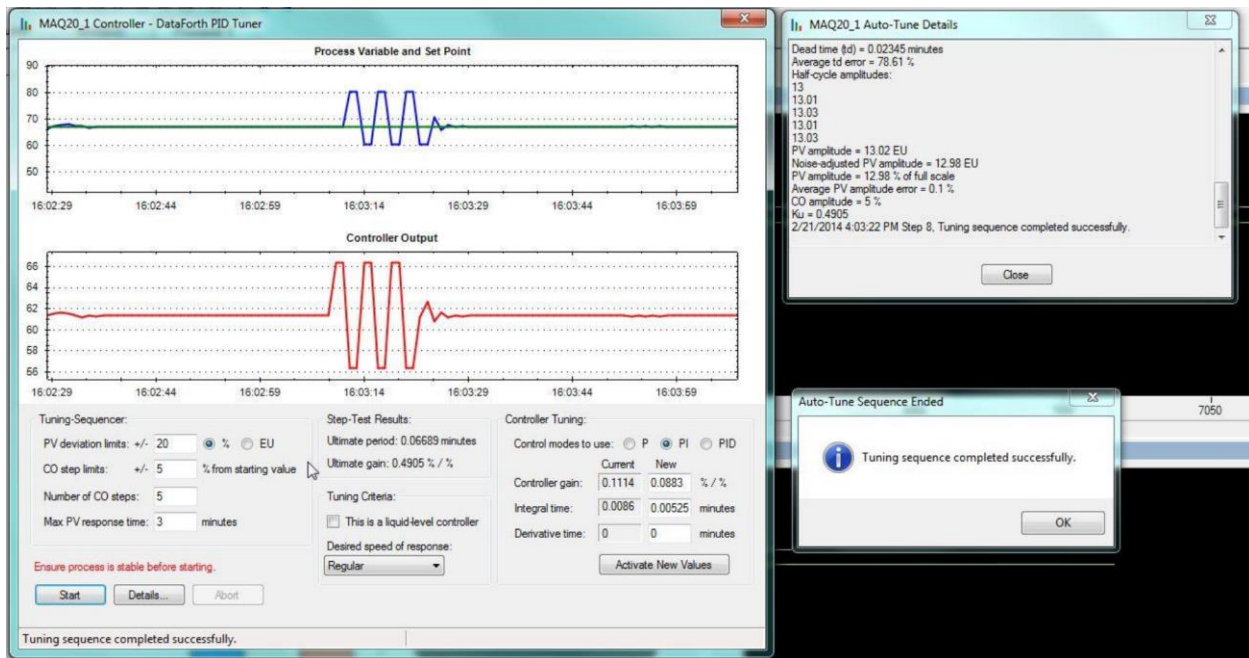

The tuning process is initiated by clicking the [Start] button in the lower left corner of the window. When the tuning process runs, the Auto-Tune Details window opens and lists the tuning process steps as they occur, displaying measured results. If the process is stable and can be tuned, the Auto-Tuner will converge and a message box will indicate success.

The current and new values for the controller parameters are displayed in the lower right portion of the Auto-Tuner window. To apply these optimized values to the controller, press the [Activate New Values] button. The new controller parameters can be tested by closing the Auto-Tuner windows, adjusting the Setpoint, and observing the controller response. Default values for some Auto-Tuner parameters such as PV deviation limits and CO step limits may need to be adjusted for the tuning process to converge. Start with the default values, tune the controller, and observe the messages in the Auto-Tune Details window for recommendations on parameter changes.

### 6.2.1 PID – Temperature and Flow Controller

A typical occurrence in industrial manufacturing is the failure of controllers on legacy equipment. Direct replacement of controllers for legacy equipment can be difficult and almost impossible in cases where custom firmware was used on the discontinued system. The MAQ®20 Data Acquisition and Control System is a low-cost option for use in such applications. The methods outlined within Section 6.2 of this document were implemented in regards to an industrial PID process simulator that was previously used for educational purposes and no longer functional.

The industrial process simulator hardware is composed of a variable speed fan directed towards heating coils located in the center of an insulated tube. An RTD sensor located near the coils was used for temperature measurement and a transmitter at the end of the insulated tube was used to measure the pressure of the airflow exiting the system in pascals.



Outputs and inputs to the flow and heating hardware are standard process currents of 4-20mA and were previously wired to individual PID controllers on the faceplate of the device.



Inputs and outputs from the PID controllers were removed and connected to a single MAQ®20 Data Acquisition System. A MAQ20-IDN module was used for monitoring system response as the product variable (PV) through current input and a MAQ20-IO was used to provide system excitation as the control output (CO).

A present panel was developed in ReDAQ® Shape Software to mimic the aesthetics and active PID display outputs of the non-functioning industrial electronic equipment. This was done using images of the equipment as a background and overlaying application graphical user interfaces (GUIs) from ReDAQ® Shape Software's Toolbox selection.

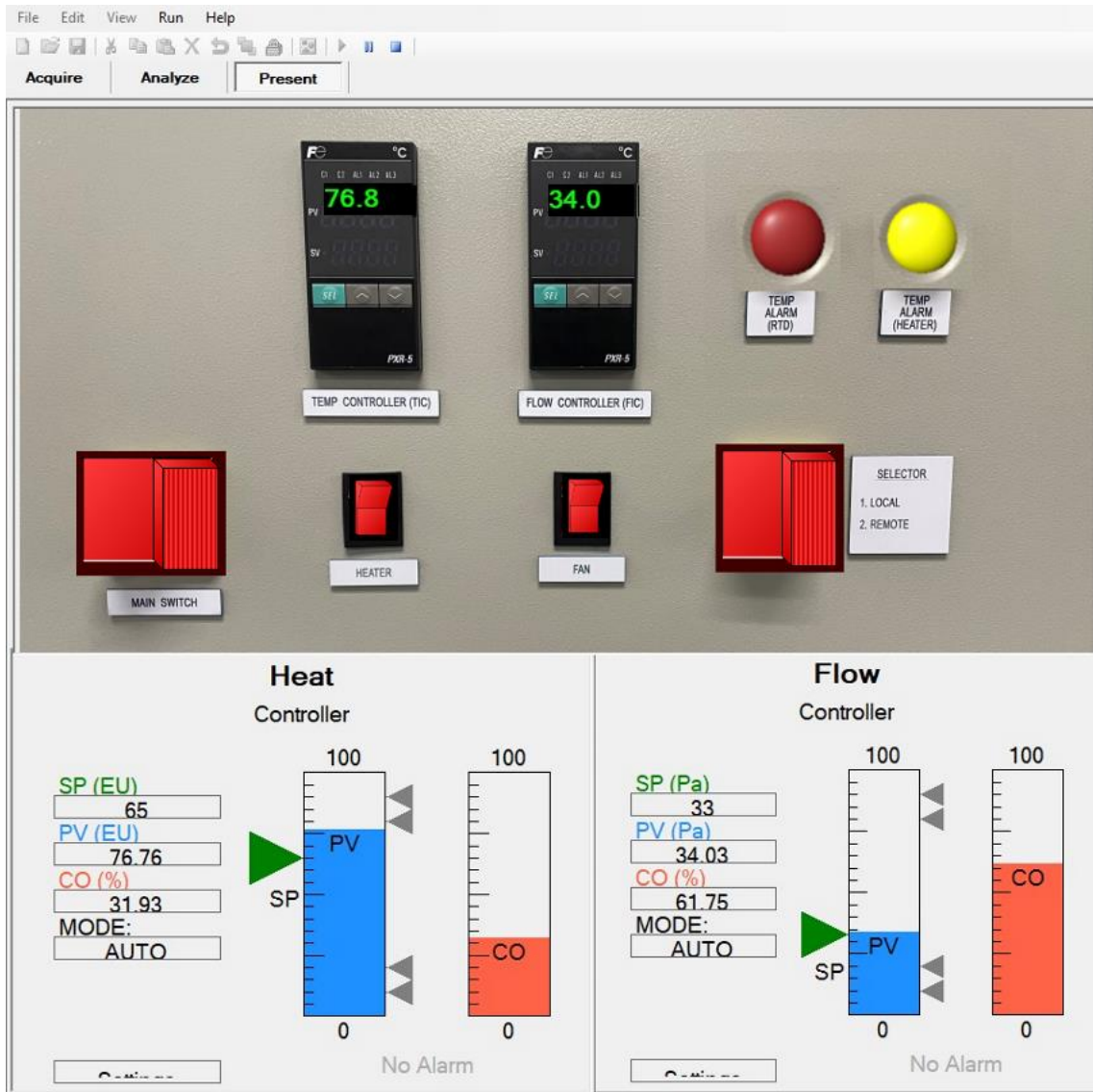

All functionality provided by physical inputs to the industrial process simulator were mirrored by the interactive GUIs from ReDAQ® Shape Software's Toolbox selection. This allowed for remote control of the system through the MAQ®20 Data Acquisition System's ethernet TCP interface. Two PID faceplates were used for control of the PID processes, while additional functionalities were provided by the GUIs overlaid on the background image of the industrial hardware.

Like the example shown in Section 6.2 of this document, ReDAQ® Shape Software's PID Tuning tool was used to derive the optimal values related to controller gain and integral time.

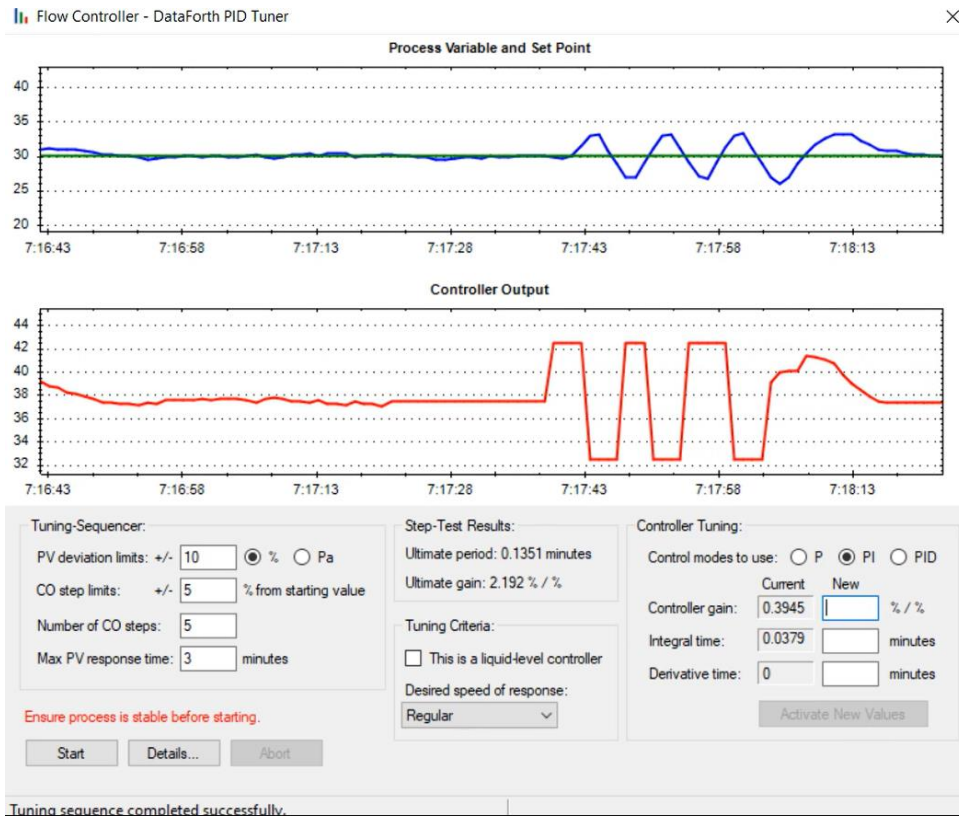

Upon completion of the tuning process, the PID Control panel tool was set to Auto Mode and was able to maintain the setpoint specified by the user's input by varying the output of the associated MAQ20-IO channels.

### 6.3 SCMPB01 Backpanel Display

The MAQ20-5B26-0.x transition cable can be used to interface a MAQ20-VSN module to one of the 26-pin ribbon cable connectors located on SCMPB01 and SCMPB05 backpanels. This allows for SCM5B modules configured with voltage outputs to be recorded through the 16 channels of the MAQ20-VSN voltage input module without the need for complex wiring by the user.

For demonstration purposes, a present panel with a background image of the SCMPB01 backpanel with attached modules was implemented to provide continuous data output from the analog modules. This simplistic interface was implemented with the use of the Label and Text Tools from ReDAQ® Shape Software's Toolbox selection. The color of the label backgrounds were set to match the anti-static mat that the image of the SCMPB01 backpanel was taken over.

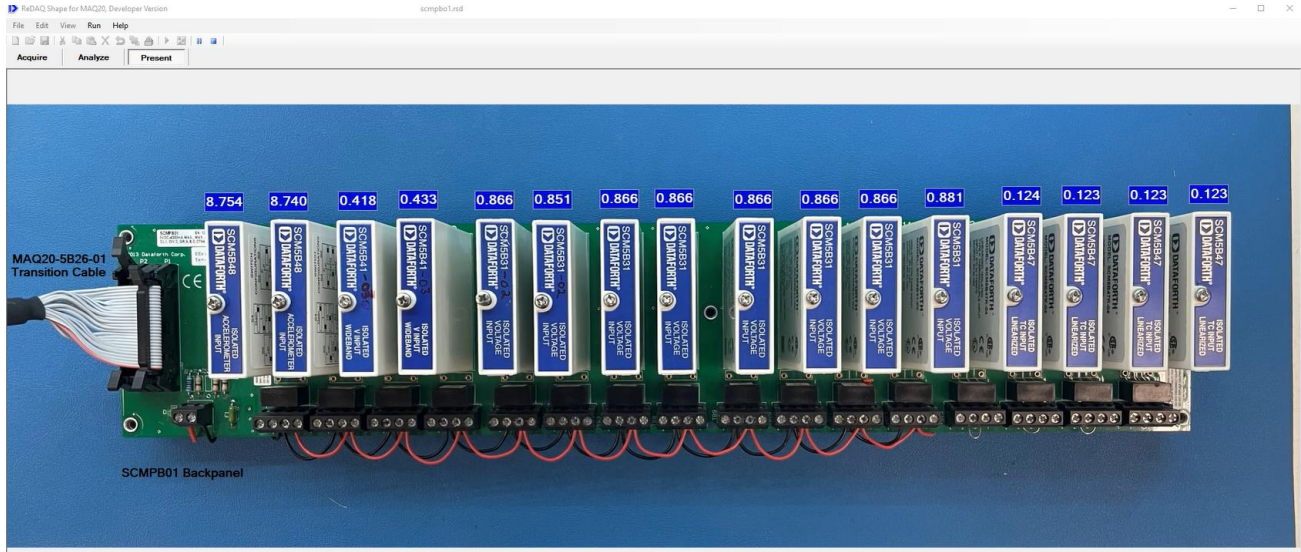

Use of the MA20-5B26-0.x cable is only recommended for users who already have an existing stock of compatible SCM5B modules and require a method of digital acquisition. When used in this arrangement, it should be noted that combined accuracy of the system will be sum of SCM5B module accuracy and MAQ20-VSN module accuracy.

#### 6.4 Battery Cell Monitor

A system for monitoring potentials of individual and stacked battery cells was implemented with the use of a MAQ®20 Data Acquisition System. The system was composed of a MAQ20-COM4 communication module, two MAQ20-ISOV2 isolated differential voltage input modules, and a MAQ20-TTC thermocouple input module for measuring temperatures of the battery stacks. The modules were placed in a small enclosure with connections made to switches, LEDs, and seven segment displays.



External series resistors were arranged to allow for a total stack voltage of 160 VDC to be measured within the channel limits of the MAQ20-ISOV2 isolated voltage input modules. Total battery stack voltage



was also displayed discretely through the illumination of the four LEDs on the top left side of the enclosure, with four LEDs at full brightness indicating a total stack voltage of 160 VDC.

The example shown below is a present panel that was created using GUIs from the toolbox selection within ReDAQ® Shape Software.

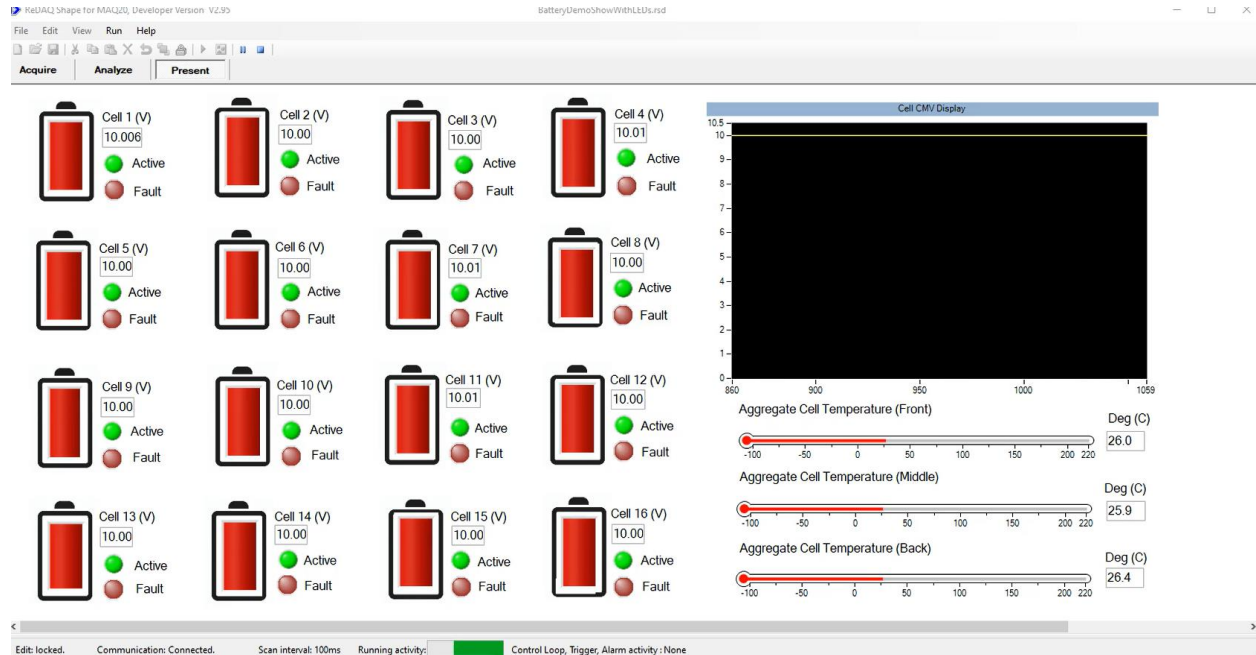

Bar graphs, numeric text output, and LEDs were connected to individual channels of the MAQ20-ISOV2 modules to provide both visual and continuous data output to the user. The LED GUIs were configured with a tracking low-alarm to indicate a fault condition in the event of a voltage cell dropping below a specified level. Thermocouples were placed on the top, bottom, and center of the battery stack to provide temperature data on the present panel. The image below shows the occurrence of faults on cells 14 and 15, indicated by the illumination of the associated fault LEDs.

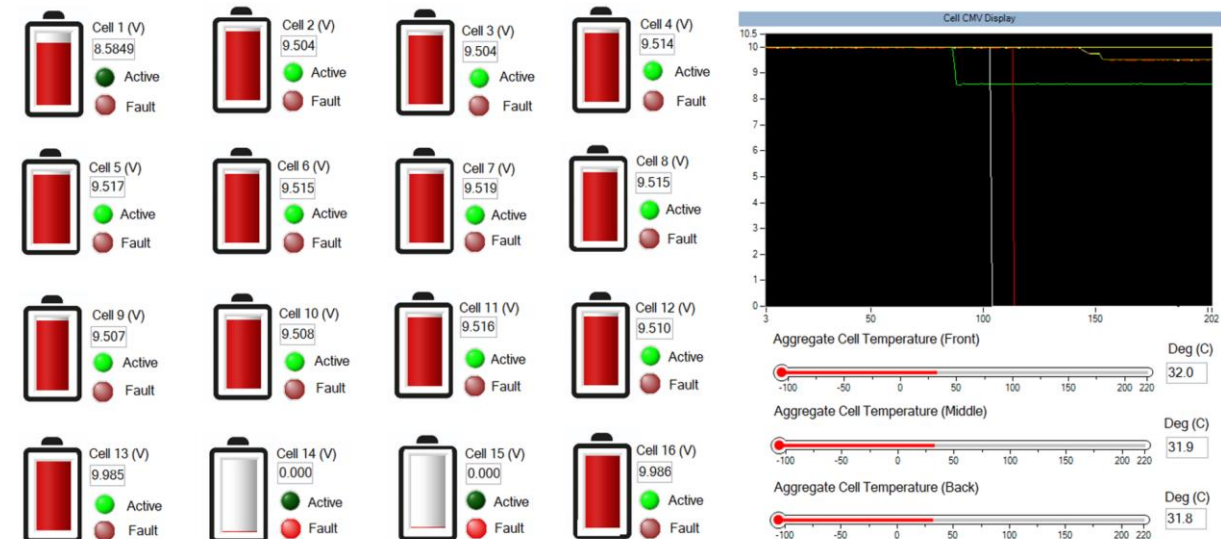

The MAQ®20 Data Acquisition System can communicate simultaneously through its three available communication interfaces, allowing for data to be streamed by multiple software instances from a single host system, or by multiple host systems. A Python implementation using the MAQ20 Python API was also developed to output individual and total battery stack voltages.

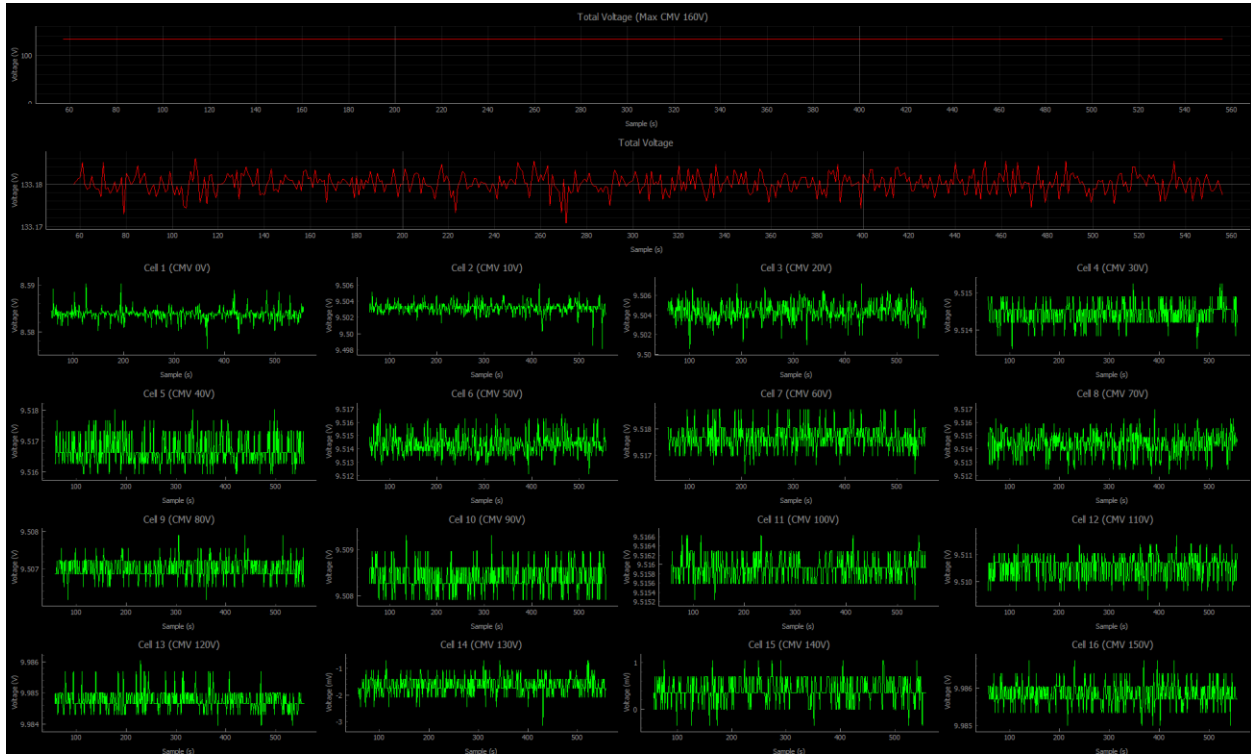

The Python implementation allowed for a more data focused implementation with coarse and fine views of the total stack voltage, along with individual cell voltages. Use of the Python API provides complete customization of displayed outputs and control of MAQ®20 Data Acquisition System in ways not always possible with ReDAQ® Shape Software. Additional information on the MAQ®20 Python API can be found in the MA1064 MAQ20 Python API User Manual.

## 6.5 Remote Weather Station

MAQ®20 Data Acquisition Systems can be used in remote locations when connected to a cellphone modem through the MAQ20-COMx's ethernet interface. To demonstrate this capability, a weather station was installed on the roof of Dataforth's headquarters in Tucson, Arizona. The system was composed of the following modules:

- MAQ20-MVDN: Temperature, humidity, and barometric pressure measurements.
- MAQ20-VO: Voltage excitation for temperature, humidity, and barometric pressure sensors.
- MAQ20-RTD31: Wind direction measurement.
- MAQ20-FREQ: Wind speed and rain gauge measurements.
- MAQ20-TTC: Temperature measurements outside and within control cabinet.

The hardware and sensors mounted on the roof of the building were connected through a weatherproof conduit to an enclosed control box located inside of the building. Given the location of the installment, a cellar modem was not required but was used for demonstration purposes.



To demonstrate the flexibility of software integration with the MAQ®20 Data Acquisition System, a present panel was developed in in Python using the MAQ20 Python API as an interface.



## 6.6 Process Simulator

To demonstrate the variety of functionalities provided by the MAQ®20 Data Acquisition System, an interactive system was designed with the following module population:

- MAQ20-COM4: Communication Module.
- MAQ20-JTC: 8-Channel Thermocouple Input Module.
- MAQ20-VDN: 8-Channel Differential Voltage Module.
- MAQ20-VO: 8-Channel Voltage Output Module.
- MAQ20-DIOL: 8-Channel Digital Input/Output Module.

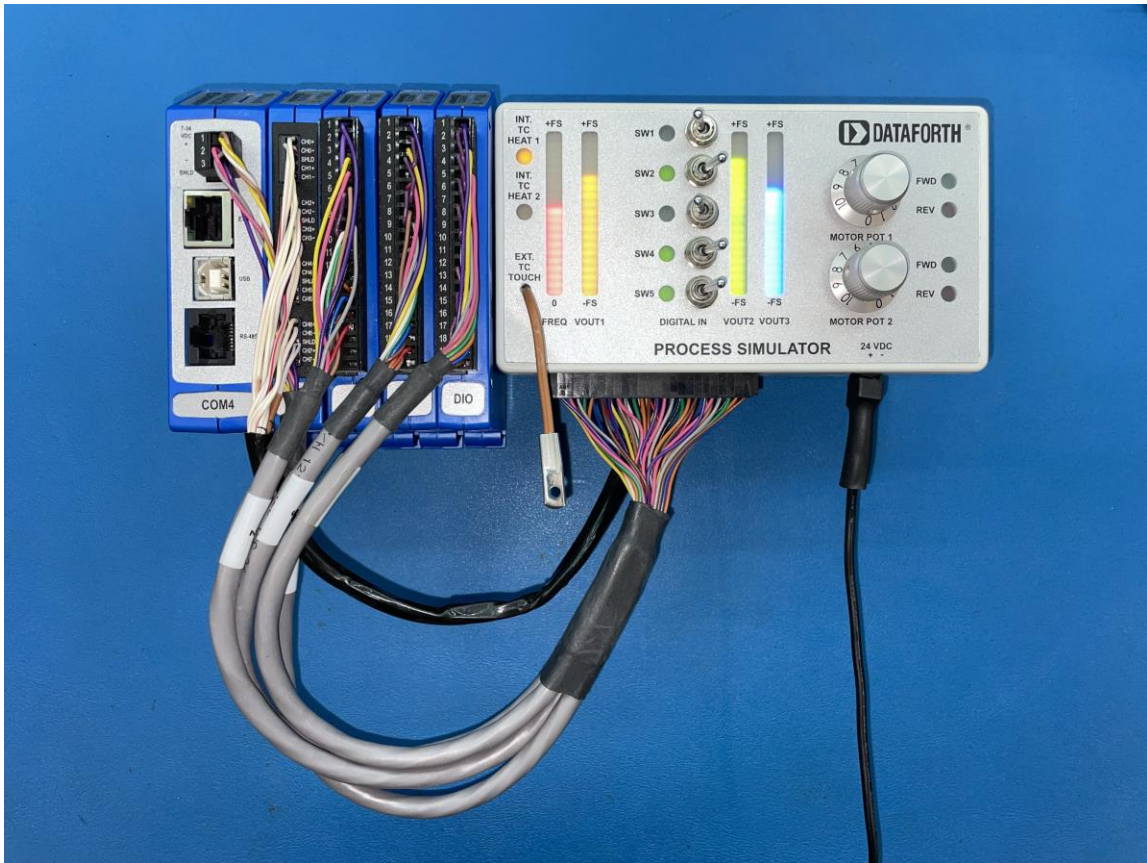

On the demonstration system, the MAQ20-JTC module Ch 7 measures the thermocouple protruding from the Process Simulator.

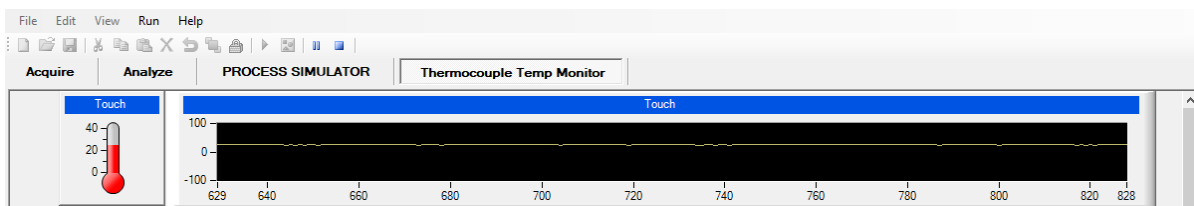



The orange LED bar display is controlled by MAQ20-VO Ch 0. MAQ20-VDN module Ch 0 measures a 0 to 3V signal for the green LED bar display, labeled VOUT2. The green LED bar display is controlled by Motor Pot 1 when MAQ20-VO Ch 1 is set to -10V and it is controlled by MAQ20-VO Ch 2 when MAQ20-VO Ch 1 is set to +10V.

MAQ20-DIOL module input channels DI0 through DI4 are connected to bat toggle switches SW1 through SW5 respectively. The discrete input channels read logic 1 for the bat toggle switch in the left position and the LED off and logic 0 for the bat toggle switch in the right position and the LED on. MAQ20-DIOL module output channels DO1 and DO2 are connected to Motor Pot 1 FWD and REV controls respectively and output channels DO3 and DO4 are connected to Motor Pot 2 FWD and REV controls respectively. MAQ20-VDN module Ch 0 measures a 0 to 3V signal for the green LED bar display, labeled VOUT2 and MAQ20-VDN module Ch 2 measures a 0 to 3V signal for the blue LED bar display, labeled VOUT3. The green LED bar display is controlled by Motor Pot 1 when MAQ20-VO Ch 1 is set to -10V and the blue LED bar display is controlled by Motor Pot 2 when MAQ20-VO Ch 1 is set to -10V.

Control of the process simulator occurs through a custom made present panel or by direct interaction with the hardware. Any changes to the digital panel or to the physical the hardware are mirrored at an update rate of 10ms.

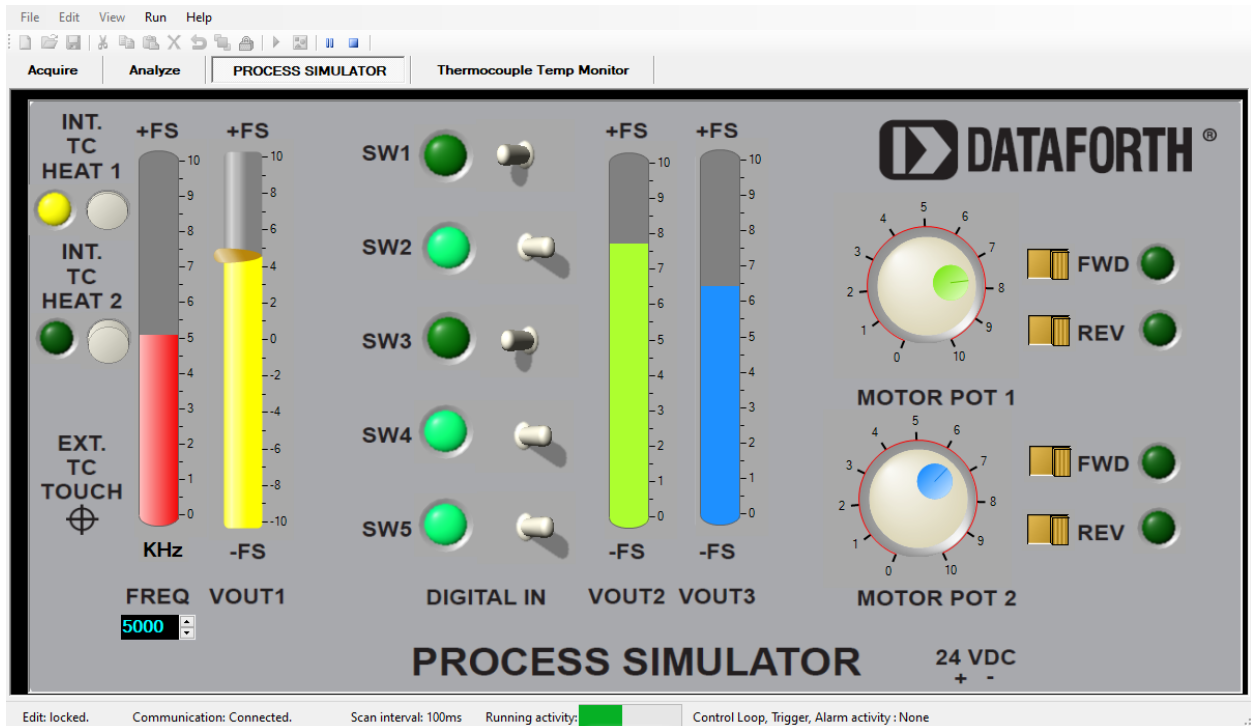



## 7.0 Advance Features

### 7.1 Modbus TCP Logger

ReDAQ® Shape Software can be configured to record internal Modbus TCP communications to a log file during program execution. This feature must be enabled prior to connecting to the MAQ®20 Data Acquisition System through a TCP connection in ReDAQ® Shape Software.

The Modbus Logger feature can be enabled using the view pull-down menu:

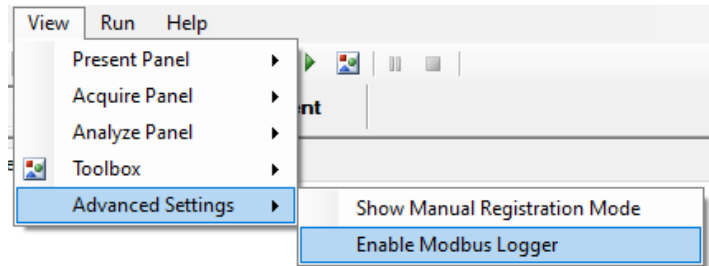

Following program execution, the generated log file can be found in the ReDAQ Shape MAQ20 subfolder located within the Dataforth folder in the user's Documents.

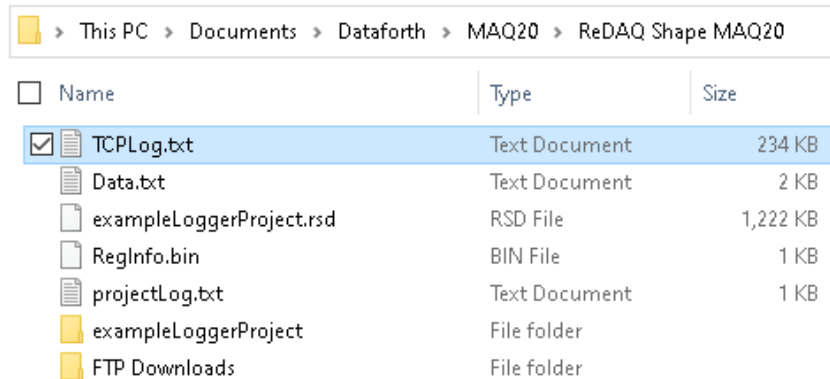

The logfile is populated with timestamped Modbus requests and response data. Information on cumulative retries on Modbus request are also logged within the file.

```

TCPLog.txt
1 12:29:04.374 PM: [192.168.0.232] : WRITE MULTIPLE: Address: 1020, numData: 1
2 12:29:04.376 PM: [192.168.0.232] : READ MULTIPLE: Address: 0, numData: 10
3 12:29:04.377 PM: [192.168.0.232] : READ RESULT: data: {77, 65, 81, 50, 48, 45, 67, 79, 77, 50, } ~ 0.997 ms ~ Num Retries: 0
4 12:29:04.383 PM: [192.168.0.232] : READ MULTIPLE: Address: 0, numData: 10
5 12:29:04.384 PM: [192.168.0.232] : READ RESULT: data: {77, 65, 81, 50, 48, 45, 67, 79, 77, 50, } ~ 1.0215 ms ~ Num Retries: 0
6 12:29:04.384 PM: [192.168.0.232] : READ MULTIPLE: Address: 20, numData: 10
7 12:29:04.386 PM: [192.168.0.232] : READ RESULT: data: {48, 49, 54, 51, 50, 49, 54, 45, 48, 49, } ~ 0.9736 ms ~ Num Retries: 0
8 12:29:04.386 PM: [192.168.0.232] : READ MULTIPLE: Address: 30, numData: 5
9 12:29:04.387 PM: [192.168.0.232] : READ RESULT: data: {68, 48, 51, 50, 51, } ~ 1.0308 ms ~ Num Retries: 0
10 12:29:04.387 PM: [192.168.0.232] : READ MULTIPLE: Address: 35, numData: 5
11 12:29:04.389 PM: [192.168.0.232] : READ RESULT: data: {70, 51, 46, 56, 49, } ~ 0.9641 ms ~ Num Retries: 0
12 12:29:04.389 PM: [192.168.0.232] : READ MULTIPLE: Address: 1210, numData: 1
13 12:29:04.390 PM: [192.168.0.232] : READ RESULT: data: {42, } ~ 1.0256 ms ~ Num Retries: 0
14 12:29:04.390 PM: [192.168.0.232] : READ MULTIPLE: Address: 42, numData: 6
15 12:29:04.392 PM: [192.168.0.232] : READ RESULT: data: {112, 179, 213, 111, 162, 222, } ~ 0.9695 ms ~ Num Retries: 0
    
```

The log file is intended for debugging purposes by the user, or can be provided to Dataforth's Technical Support team if issues with system hardware or software are suspected.

## 7.2 Manual Module Registration Mode

In instances where modules are connected to a system but are not required for use for a given application, Manual Registration Mode can be enabled. In this mode, system population does not occur automatically, but instead through manual entry of the desired modules by the user.

This feature must be enabled prior to connecting to the MAQ®20 Data Acquisition System.

The option to enable Manual Register Mode can be made visible to the user by selecting the Show Manual Registration Mode option in the View pull-down menu:

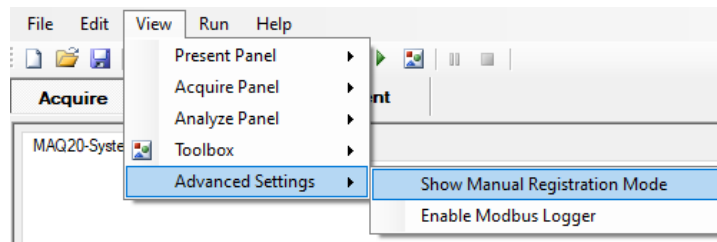

A checkbox located underneath the system name will then become visible and can be selected to enable Manual Registration Mode.

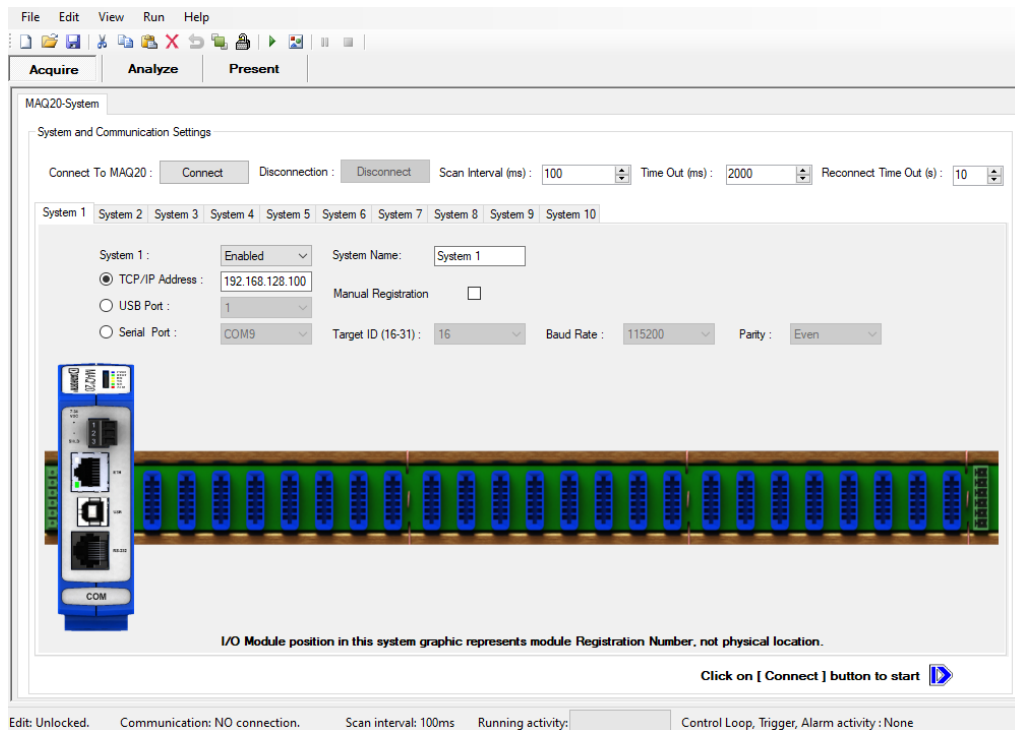

Once connected to the MAQ®20 Data Acquisition System, click on the image of the MAQ20-COMx module to access the System Summary Tab. Click the [Manual Register Module] button within the tab and an input pop-up screen will appear:

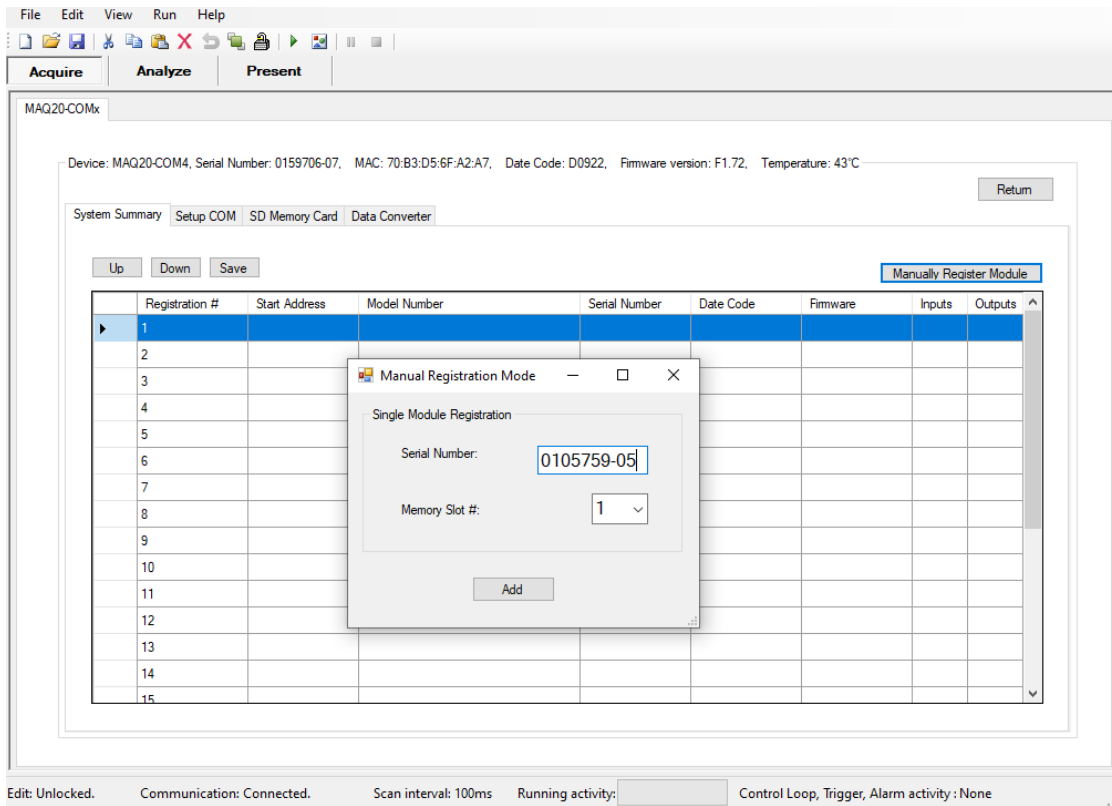

Clicking the [Add] button after entering the modules serial number and the desired slot number will populate the module with the matching serial number in the specified slot number. The process listed in this section can be repeated to add additional modules to the system.

## DATAFORTH WARRANTY

### Applying to Products Sold by Dataforth Corporation

a. **General.** Dataforth Corporation (“Dataforth”) warrants that its products furnished under this Agreement will, at the time of delivery, be free from defects in material and workmanship and will conform to Dataforth's applicable specifications or, if appropriate, to buyer's specifications accepted in writing by Dataforth. DATAFORTH'S OBLIGATION OR LIABILITY TO BUYER FOR PRODUCTS WHICH DO NOT CONFORM TO THE ABOVE STATED WARRANTY SHALL BE LIMITED TO DATAFORTH, AT DATAFORTH'S SOLE DISCRETION, EITHER REPAIRING, REPLACING, OR REFUNDING THE PURCHASE PRICE OF THE DEFECTIVE PRODUCT(S) PROVIDED THAT WRITTEN NOTICE OF SAID DEFECT IS RECEIVED BY DATAFORTH WITHIN THE TIME PERIODS SET FORTH BELOW:

i. for all software products including licensed programs, thirty (30) days from date of initial delivery;

ii. for all hardware products including complete systems, one (1) year from date of initial delivery;

iii. for all special products, sixty (60) days from date of initial delivery; and

further, all products warranted hereunder for which Dataforth has received timely notice of nonconformance must be returned FOB to Dataforth's plant in Tucson, Arizona USA within thirty (30) days after the expiration of the warranty periods set forth above.

The foregoing warranties shall not apply to any products which Dataforth determines have, by buyer or otherwise, been subjected to operating and/or environmental conditions in excess of the maximum value established therefore in the applicable specifications, or any products that have been the subject of mishandling, misuse, misapplication, neglect, improper testing, repair, alteration or damage. THE PROVISIONS OF THE FOREGOING WARRANTIES EXTEND TO BUYER ONLY AND NOT TO BUYER'S CUSTOMERS OR USERS OF BUYER'S PRODUCTS. THE DATAFORTH STANDARD WARRANTY IS IN LIEU OF ALL WARRANTIES OF MERCHANTABILITY AND FITNESS FOR A PARTICULAR PURPOSE OR USE AND ALL OTHER WARRANTIES WHETHER EXPRESS, IMPLIED OR STATUTORY, EXCEPT AS TO TITLE. THE DATAFORTH STANDARD WARRANTY MAY BE CHANGED BY DATAFORTH WITHOUT NOTICE.

b. **Buyer Indemnity.** Buyer agrees to indemnify and hold Dataforth harmless from and against any and all claims, damages and liabilities whatsoever asserted by any person, entity, industry organization, government, or governmental agency of any country resulting

directly or indirectly (i) from any acts not authorized by Dataforth in writing or any statements regarding the products inconsistent with Dataforth's product documentation or standard warranty, or (ii) from any breach or threatened breach by buyer, or by any of its employees or agents, of any term, condition or provision of this Warranty or (iii) from any warranty, representation, covenant or obligation given by buyer to any third party and not expressly provided for in this Warranty or (iv) for any non-compliance (in any form) of the products with any necessary or mandatory applicable laws, regulations, procedures, government or industry policies or requirements related to the use, sale or importation of the products. Such indemnification shall include the payment of all reasonable attorneys' fees and other costs incurred by Dataforth in defending such claim.

c. **Limitation on Damages.**

(1) IN NO EVENT SHALL DATAFORTH, ITS SUPPLIERS, LICENSORS, SERVICE PROVIDERS, EMPLOYEES, AGENTS, OFFICERS, AND DIRECTORS BE LIABLE FOR INDIRECT, SPECIAL, INCIDENTAL, COVER, ECONOMIC, PUNITIVE, ACTUAL, EXEMPLARY, CONSEQUENTIAL OR OTHER DAMAGES OF ANY NATURE INCLUDING, WITHOUT LIMITATION, LOST PROFITS OR REVENUES, COSTS OF REPLACEMENT PRODUCTS, LOSS OR DAMAGE TO DATA ARISING OUT OF THE USE OR INABILITY TO USE ANY DATAFORTH PRODUCT.

(2) IN NO EVENT SHALL DATAFORTH BE LIABLE FOR DIRECT, SPECIAL, INDIRECT, INCIDENTAL OR CONSEQUENTIAL DAMAGES OF ANY NATURE RESULTING FROM BUYER'S NONCOMPLIANCE (IN ANY FORM) WITH ALL NECESSARY OR MANDATORY APPLICABLE LAWS, REGULATIONS, PROCEDURES, GOVERNMENT POLICIES OR REQUIREMENTS RELATED TO THE USE, SALE OR IMPORTATION OF PRODUCTS.

(3) IN NO EVENT WILL THE COLLECTIVE LIABILITY OF DATAFORTH AND ITS SUPPLIERS, LICENSORS, SERVICE PROVIDERS, EMPLOYEES, AGENTS, OFFICERS, AND DIRECTORS TO ANY PARTY (REGARDLESS OF THE FORM OF ACTION, WHETHER BASED UPON WARRANTY, CONTRACT, TORT, OR OTHERWISE) EXCEED THE GREATER OF EITHER US\$1000.00 (ONE THOUSAND DOLLARS U.S.A. CURRENCY) OR THE AMOUNT PAID TO DATAFORTH FOR THE APPLICABLE PRODUCT OR SERVICE OUT OF WHICH LIABILITY AROSE.

(4) DATAFORTH'S LIABILITY ARISING OUT OF THE PRODUCTION, SALE OR SUPPLY OF PRODUCTS

OR THEIR USE OR DISPOSITION, WHETHER BASED UPON WARRANTY, CONTRACT, TORT OR OTHERWISE, SHALL NOT EXCEED THE GREATER OF EITHER US\$1000.00 (ONE THOUSAND DOLLARS U.S.A. CURRENCY) OR THE ACTUAL PURCHASE PRICE PAID BY BUYER FOR DATAFORTH'S PRODUCTS. DATAFORTH'S LIABILITY FOR ANY CLAIM OF ANY KIND SHALL IN NO CASE EXCEED THE OBLIGATION OR LIABILITY SPECIFIED IN THIS WARRANTY.

d. **Technical Assistance.** Dataforth 's Warranty as hereinabove set forth shall not be enlarged, diminished or affected by, and no obligation or liability shall arise or grow out of, Dataforth's rendering of technical advice, facilities or service in connection with buyer's order of the products furnished hereunder.

e. **Warranty Procedures.** Buyer shall notify Dataforth of any products which it believes to be defective during the applicable warranty period and which are covered by the Warranty set forth above. Buyer shall not return any products for any reason without the prior authorization of Dataforth and issuance of a Return Material Authorization ("RMA") number. After issuance of a RMA number, such products shall be promptly returned by buyer (and in no event later than thirty (30) days after the Warranty expiration date), transportation and insurance prepaid, to Dataforth's designated facility for examination and testing. Dataforth shall either repair or replace any such products found to be so defective and promptly return such products to buyer, transportation and insurance prepaid. Should Dataforth's examination and testing not disclose any defect covered by the foregoing Warranty, Dataforth shall so advise buyer and dispose of or return the products in accordance with buyer's instructions and at buyer's sole expense, and buyer shall reimburse Dataforth for testing

expenses incurred at Dataforth's then current repair rates.

f. **Repair Warranty.** Dataforth warrants its repair work and/or replacement parts for a period of ninety (90) days from receipt by buyer of the repaired or replaced products or for the remainder of the warranty period for the initial delivery of such order as set forth in paragraph a above, whichever is greater.

g. **Critical Applications.** Certain applications using Dataforth's products may involve potential risks of death, personal injury, or severe property or environmental damage ("Critical Applications"). DATAFORTH'S PRODUCTS ARE NOT DESIGNED, INTENDED, AUTHORIZED, OR WARRANTED TO BE SUITABLE FOR USE IN LIFE-SUPPORT DEVICES OR SYSTEMS, SAFETY EQUIPMENT, NUCLEAR FACILITY APPLICATIONS OR OTHER CRITICAL APPLICATIONS WHERE MALFUNCTION OF THE PRODUCT CAN BE EXPECTED TO RESULT IN PERSONAL INJURY, DEATH OR SEVERE PROPERTY DAMAGE. BUYER USES OR SELLS SUCH PRODUCTS FOR USE IN SUCH CRITICAL APPLICATIONS AT BUYER'S OWN RISK AND AGREES TO DEFEND, INDEMNIFY AND HOLD HARMLESS DATAFORTH FROM ANY AND ALL DAMAGES, CLAIMS, PROCEEDINGS, SUITS OR EXPENSE RESULTING FROM SUCH USE.

h. **Static Sensitive.** Dataforth ships all product in anti-static packages. Dataforth's Warranty as hereinabove set forth shall not cover warranty repair, replacement, or refund on product or devices damaged by static due to buyer's failure to properly ground.

## Application Support

Dataforth provides timely, high-quality product support. Call 1-800-444-7644 TOLL-FREE.

## Returns/Repair Policy

All warranty and repair requests should be directed to the Dataforth Customer Service Department at (520) 741-1404. If a product return is required, request a Return Material Authorization (RMA) number. You should be ready to provide the following information:

1. Complete product model number.
2. Product serial number.
3. Name, address, and telephone number of person returning product.
4. Special repair instructions.
5. Purchase order number for out-of-warranty repairs.

The product should be carefully packaged, making sure the RMA number appears on the outside of the package, and ship prepaid to:

**Dataforth Corporation**  
**3331 E. Hemisphere Loop**  
**Tucson, AZ 85706 USA**

The information provided herein is believed to be reliable; however, DATAFORTH assumes no responsibility for inaccuracies or omissions. DATAFORTH assumes no responsibility for the use of this information, and all use of such information shall be entirely at the user's own risk. Application information is intended as suggestions for possible use of the products and not as explicit performance in a specific application. Prices and specifications are subject to change without notice. No patent rights or licenses to any of the circuits described herein are implied or granted to any third party. DATAFORTH does not authorize or warrant any DATAFORTH product for use in life support devices and/or systems.